



Range of centrifugal roof mounted fans in horizontal discharge format:

- Very low profile design.
- Bases manufactured from galvanised sheet steel.
- Centrifugal backward curved impeller.
- External rotor motor.
- Cowl manufactured from spun aluminium.

Available, depending upon the model, with single or three phase motors in 2, 4, 6, or 8 poles.

Motors

All motors are IP54, Class F insulation with safety thermal overload protection.

Electrical supply:

Single phase 230V-50/60Hz or 230V-50Hz (CRHB) upon the model.

Three phase 400V-50/60Hz or 400V-50Hz upon the model (CRHT).

Speed controllable by Voltage.

Models with three phase motors controllable by frequency inverter.

Additional information

ON-OFF electrical isolation switch fitted.

On request

Models (315 to 560) with 2 speed motors (4/8).



Low profile

External rotor motor to limit the height of the fan.



Bird proof guard

Steel finger proof guard.



Isolation switch

ON-OFF electrical isolation switch fitted on the fan as standard.



Range of centrifugal roof mounted fans in vertical discharge format:

- Very low profile design.
- Base manufactured from galvanised sheet steel.
- Centrifugal backward curved impeller.
- External rotor motor.
- Cowl manufactured from spun aluminium.

Available, depending upon the model, with single or three phase motors in 2, 4, 6, or 8 poles.

Motors

All motors are IP54, Class F insulation with safety thermal overload protection.

Electrical supply:

Single phase 230V-50/60Hz or 230V-50Hz (CRVB) upon the model.

Three phase 400V-50/60Hz or 400V-50Hz upon the model (CRVT).

Speed controllable by voltage.

Models with three phase motors controllable by frequency inverter.

Additional information

ON-OFF electrical isolation switch fitted.

On request

Models (315 to 560) with 2 speed motors (4/8).



Backward curved centrifugal impellers

To prevent accumulation of dirt.



Bird proof guard

Steel finger proof guard.



Isolation switch

ON-OFF electrical isolation switch fitted on the fan as standard.

TECHNICAL CHARACTERISTICS

Before making any electrical connection ensure that the voltage and frequency of the mains electrical supply matches that of the fan data plate label.

Model	Supply / Voltage (V-Hz)	Speed (rpm)	Maximum absorbed power (W)	Maximum absorbed current (A)		Maximum airflow (m ³ /h)	Sound pressure level at 1,5 m (dB(A))		Temperature (°C)	Weight (kg)	Speed controller*
				230 V	400 V		Inlet	Outlet			
				SINGLE PHASE 2 POLE							
CRHB/2-225	230-50/60	2450	140	0,63	–	1.140	58	64	-40°C / +50°C	7	REB-1N
CRHB/2-250	230-50/60	2450	140	0,63	–	1.380	58	64	-40°C / +70°C	7,5	REB-1N
SINGLE PHASE 4 POLE											
CRHB/4-225	230-50/60	1450	50	0,25	–	670	48	54	-40°C / +60°C	7	REB-1N
CRHB/4-250	230-50/60	1450	50	0,25	–	795	51	54	-40°C / +70°C	7,5	REB-1N
CRHB/4-280	230-50/60	1400	85	0,4	–	1.300	54	57	-40°C / +50°C	8	REB-1N
CRHB/4-315	230-50/60	1400	140	0,6	–	1.850	58	61	-40°C / +70°C	17	REB-1N
CRHB/4-355	230-50	1370	230	0,85	–	2.980	63	64	-40°C / +70°C	21	REB-1N
CRHB/4-400	230-50/60	1400	410	2	–	4.210	64	67	-40°C / +60°C	22	REB-3
CRHB/4-450	230-50/60	1350	540	2,4	–	5.970	68	73	-40°C / +70°C	42	REB-3
CRHB/4-500	230-50	1400	1200	5,2	–	8.290	71	76	-40°C / +70°C	44	REB-10
SINGLE PHASE 6 POLE											
CRHB/6-315	230-50	965	70	0,4	–	1.260	48	52	-40°C / +70°C	17	REB-1N
CRHB/6-355	230-50	950	80	0,4	–	2.070	58	58	-40°C / +70°C	21	REB-1N
CRHB/6-400	230-50/60	935	150	0,7	–	2.800	58	58	-40°C / +60°C	22	REB-1N
CRHB/6-450	230-50/60	900	260	1,2	–	4.160	59	61	-40°C / +70°C	26	REB-2,5N
CRHB/6-500	230-50	890	340	1,5	–	5.250	58	63	-40°C / +70°C	27	REB-2,5N
CRHB/6-560	230-50	895	640	2,75	–	7.470	59	64	-40°C / +70°C	30	REB-5
CRHB/6-630	230-50	910	1000	4,9	–	10.350	59	64	-40°C / +50°C	50	REB-5
SINGLE PHASE 8 POLE											
CRHB/8-500	230-50	690	270	1,3	–	4.210	51	56	-40°C / +60°C	27	REB-2,5N
CRHB/8-560	230-50	650	360	1,6	–	5.470	51	55	-40°C / +60°C	30	REB-2,5N
CRHB/8-630	230-50	670	460	2,1	–	7.340	53	58	-40°C / +70°C	50	REB-2,5N
THREE PHASE 4 POLE											
CRHT/4-315	400-50/60	1440	140	–	0,6	1.900	58	62	-40°C / +70°C	17	RMT-1,5
CRHT/4-355	400-50/60	1410	190	–	0,6	3.140	64	68	-40°C / +60°C	21	RMT-1,5
CRHT/4-400	400-50/60	1340	290	–	0,7	4.200	63	66	-40°C / +70°C	22	RMT-1,5
CRHT/4-450	400-50/60	1215	650	–	1,8	5.770	66	71	-40°C / +70°C	42	RMT-2,5
CRHT/4-500	400-50/60	1400	1200	–	2,1	8.160	69	74	-40°C / +60°C	44	RMT-2,5
CRHT/4-560	400-50	1380	2045	–	3,76	10.800	70	76	-40°C / +40°C	47	RMT-5
THREE PHASE 6 POLE											
CRHT/6-315	400-50/60	990	85	–	0,45	1.250	48	52	-40°C / +70°C	17	RMT-1,5
CRHT/6-355	400-50/60	975	120	–	0,4	2.070	58	58	-40°C / +70°C	21	RMT-1,5
CRHT/6-400	400-50/60	950	125	–	0,4	2.780	59	58	-40°C / +60°C	22	RMT-1,5
CRHT/6-450	400-50/60	920	175	–	0,44	4.050	59	62	-40°C / +70°C	26	RMT-1,5
CRHT/6-500	400-50/60	915	250	–	0,62	5.300	59	64	-40°C / +70°C	27	RMT-1,5
CRHT/6-560	400-50/60	900	400	–	1	7.350	59	64	-40°C / +50°C	30	RMT-1,5
CRHT/6-630	400-50/60	915	800	–	1,9	10.330	60	65	-40°C / +50°C	50	RMT-2,5
THREE PHASE 8 POLE											
CRHT/8-500	400-50/60	690	180	–	0,65	4.110	49	53	-40°C / +60°C	27	RMT-1,5
CRHT/8-560	400-50/60	650	240	–	0,7	5.270	51	54	-40°C / +60°C	30	RMT-1,5
CRHT/8-630	400-50/60	635	300	–	0,7	7.110	53	57	-40°C / +70°C	50	RMT-1,5

* Three phase speed controllers (RMT) are suitable for 400V.

TECHNICAL CHARACTERISTICS

Before making any electrical connection ensure that the voltage and frequency of the mains electrical supply matches that of the fan data plate label.

Model	Supply / Voltage (V-Hz)	Speed (rpm)	Maximum absorbed power (W)	Maximum absorbed current (A)		Maximum airflow (m ³ /h)	Sound pressure level at 1,5 m (dB(A))		Temperature (°C)	Weight (kg)	Speed controller*
				230 V	400 V		Inlet	Outlet			
SINGLE PHASE 2 POLE											
CRVB/2-225	230-50/60	2450	140	0,63	–	1.030	58	64	-40°C / +50°C	7,5	REB-1N
CRVB/2-250	230-50/60	2450	140	0,63	–	1.180	58	64	-40°C / +70°C	8	REB-1N
SINGLE PHASE 4 POLE											
CRVB/4-225	230-50/60	1450	50	0,25	–	620	48	54	-40°C / +60°C	7,5	REB-1N
CRVB/4-250	230-50/60	1450	50	0,25	–	720	51	54	-40°C / +70°C	8	REB-1N
CRVB/4-280	230-50/60	1400	85	0,4	–	1.170	53	55	-40°C / +50°C	12	REB-1N
CRVB/4-315	230-50/60	1400	140	0,6	–	1.780	58	61	-40°C / +70°C	19	REB-1N
CRVB/4-355	230-50	1370	230	0,85	–	2.810	63	64	-40°C / +70°C	24	REB-1N
CRVB/4-400	230-50/60	1400	410	2	–	3.960	64	67	-40°C / +60°C	25	REB-2,5N
CRVB/4-450	230-50/60	1350	540	2,4	–	5.970	68	73	-40°C / +70°C	43	REB-5
CRVB/4-500	230-50	1400	1200	5,2	–	7.850	71	76	-40°C / +70°C	45	REB-10
SINGLE PHASE 6 POLE											
CRVB/6-315	230-50	965	70	0,4	–	1.220	48	52	-40°C / +70°C	19	REB-1N
CRVB/6-355	230-50	950	80	0,4	–	1.960	58	58	-40°C / +70°C	24	REB-1N
CRVB/6-400	230-50/60	935	150	0,7	–	2.640	58	58	-40°C / +60°C	25	REB-1N
CRVB/6-450	230-50/60	900	260	1,2	–	4.160	59	61	-40°C / +70°C	27	REB-2,5N
CRVB/6-500	230-50	890	340	1,5	–	49.60	58	63	-40°C / +70°C	28	REB-2,5N
CRVB/6-560	230-50	895	640	2,75	–	7.170	59	64	-40°C / +70°C	32	REB-5
CRVB/6-630	230-50	910	1000	4,9	–	9.790	59	64	-40°C / +50°C	53	REB-5
SINGLE PHASE 8 POLE											
CRVB/8-500	230-50	690	270	1,3	–	4.000	51	56	-40°C / +60°C	28	REB-2,5N
CRVB/8-560	230-50	650	360	1,6	–	5.250	51	55	-40°C / +60°C	32	REB-2,5N
CRVB/8-630	230-50	670	460	2,1	–	7.190	53	58	-40°C / +70°C	53	REB-2,5N
THREE PHASE 4 POLE											
CRVT/4-315	400-50/60	1440	140	–	0,6	1.830	58	62	-40°C / +70°C	19	RMT-1,5
CRVT/4-355	400-50/60	1410	190	–	0,6	3.020	64	68	-40°C / +60°C	24	RMT-1,5
CRVT/4-400	400-50/60	1340	290	–	0,7	3.950	63	66	-40°C / +70°C	25	RMT-1,5
CRVT/4-450	400-50/60	1215	650	–	1,8	5.770	66	71	-40°C / +70°C	43	RMT-2,5
CRVT/4-500	400-50/60	1400	1200	–	2,1	7.740	69	74	-40°C / +60°C	45	RMT-2,5
CRVT/4-560	400-50	1380	2045	–	3,76	10.110	70	76	-40°C / +40°C	49	RMT-5
THREE PHASE 6 POLE											
CRVT/6-315	400-50/60	990	85	–	0,45	1.200	48	52	-40°C / +70°C	19	RMT-1,5
CRVT/6-355	400-50/60	975	120	–	0,4	1.970	58	58	-40°C / +70°C	24	RMT-1,5
CRVT/6-400	400-50/60	950	125	–	0,4	2.610	59	58	-40°C / +60°C	25	RMT-1,5
CRVT/6-450	400-50/60	920	175	–	0,44	4.050	59	62	-40°C / +70°C	27	RMT-1,5
CRVT/6-500	400-50/60	915	250	–	0,62	5.020	59	64	-40°C / +70°C	28	RMT-1,5
CRVT/6-560	400-50/60	900	400	–	1	6.870	59	64	-40°C / +50°C	32	RMT-1,5
CRVT/6-630	400-50/60	915	800	–	1,9	9.790	60	65	-40°C / +50°C	53	RMT-2,5
THREE PHASE 8 POLE											
CRVT/8-500	400-50/60	690	180	–	0,65	3.900	49	53	-40°C / +60°C	28	RMT-1,5
CRVT/8-560	400-50/60	650	240	–	0,7	4.930	51	54	-40°C / +60°C	32	RMT-1,5
CRVT/8-630	400-50/60	635	300	–	0,7	6.680	53	57	-40°C / +70°C	53	RMT-1,5

* Three phase speed controllers (RMT) are suitable for 400V.

PERFORMANCE CURVES CRHB/CRHT

The values are sound pressure levels measured at 1,5 m, in free field conditions, at the fan inlet (black) and outlet (blue).

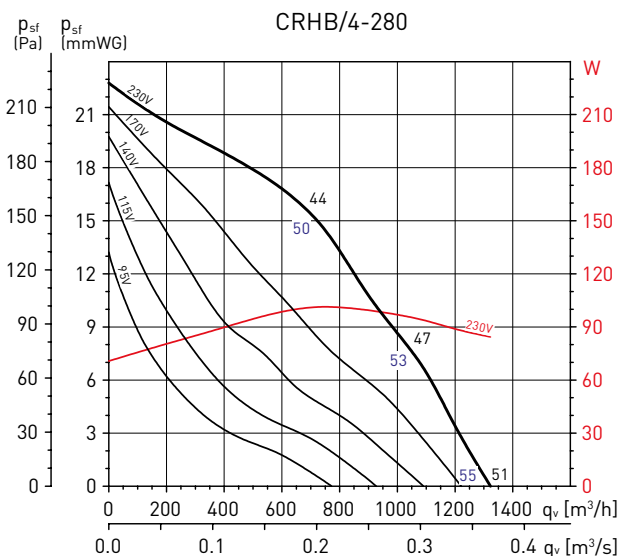
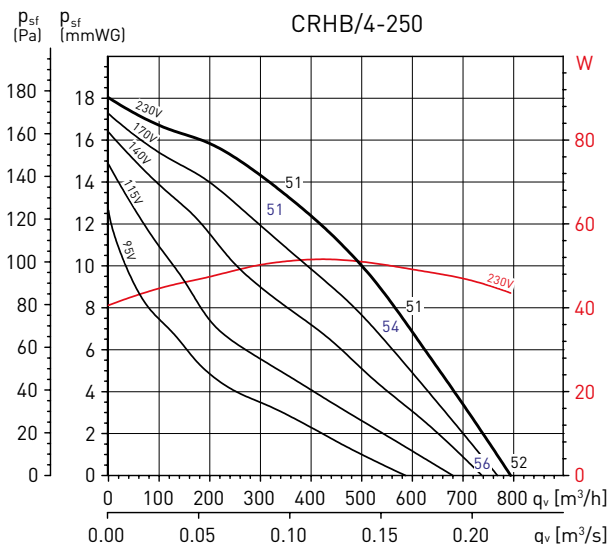
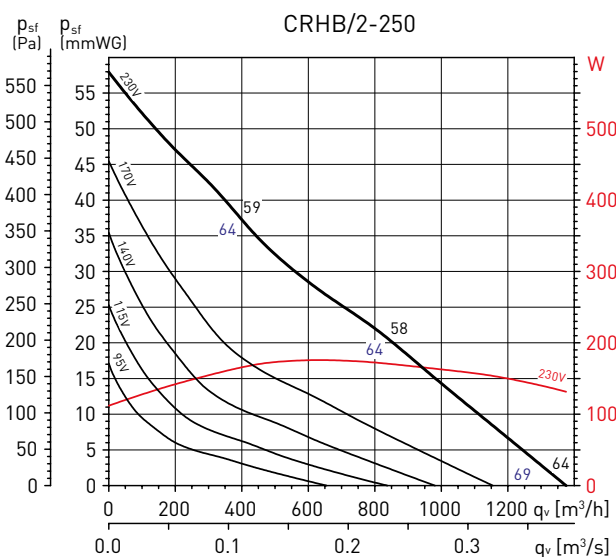
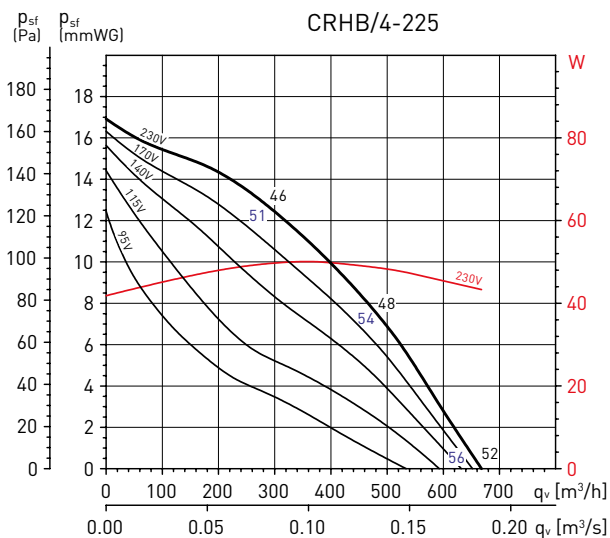
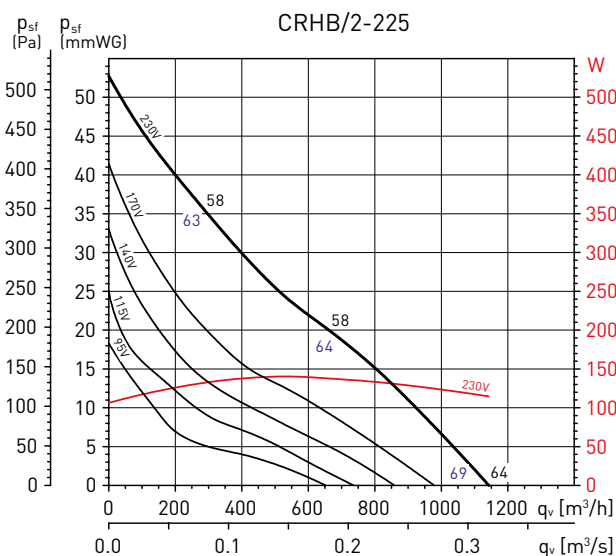

PERFORMANCE CURVES CRHB/CRHT

The values are sound pressure levels measured at 1,5 m, in free field conditions, at the fan inlet (black) and outlet (blue).

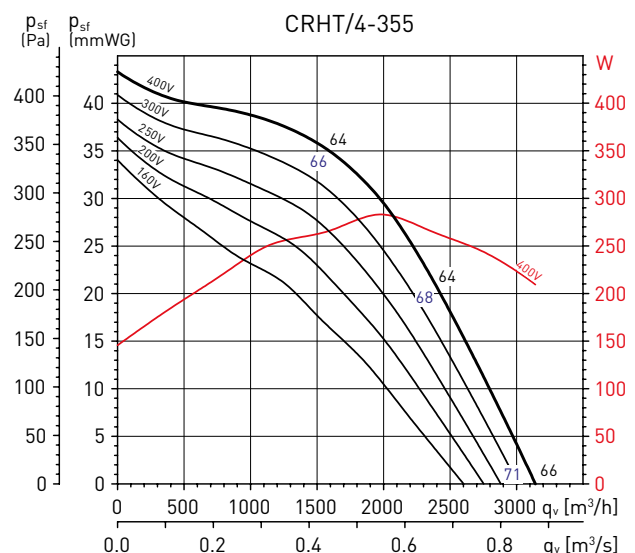
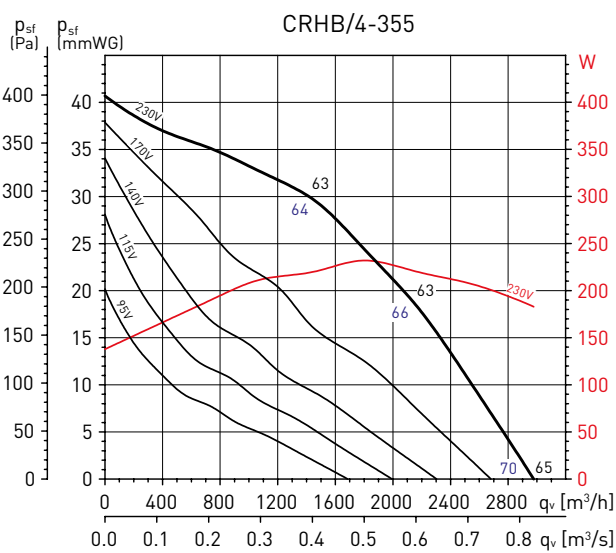
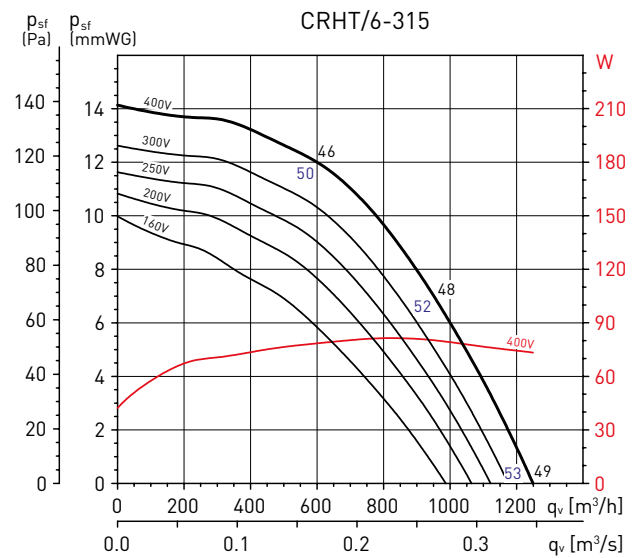
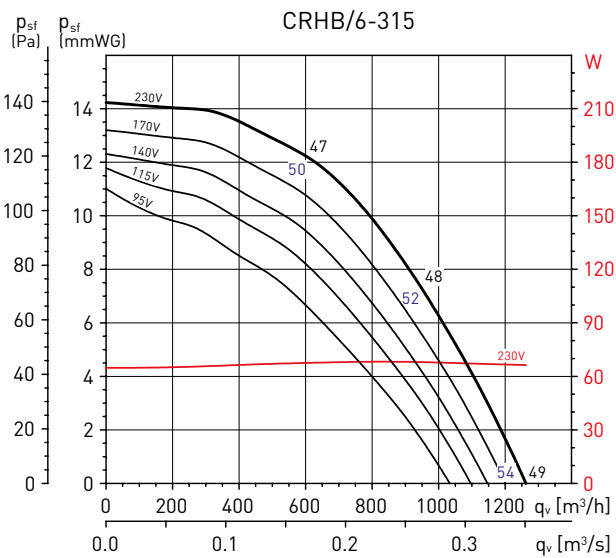
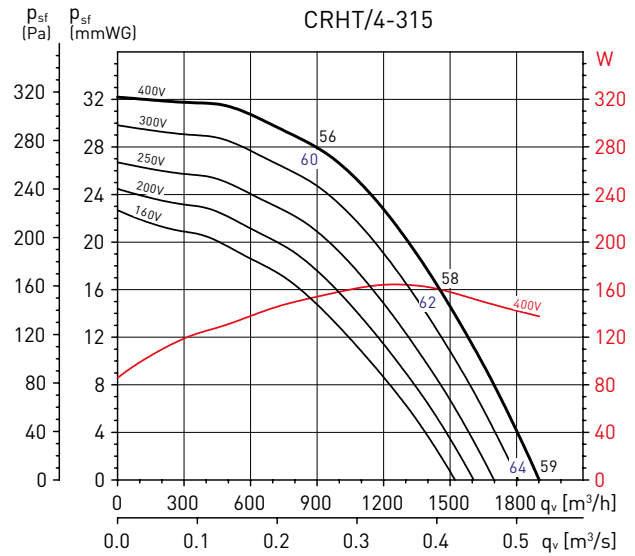
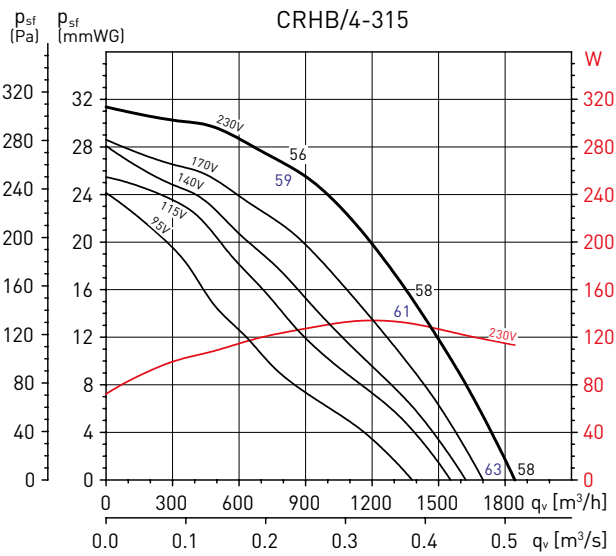

PERFORMANCE CURVES CRHB/CRHT

The values are sound pressure levels measured at 1,5 m, in free field conditions, at the fan inlet (black) and outlet (blue).

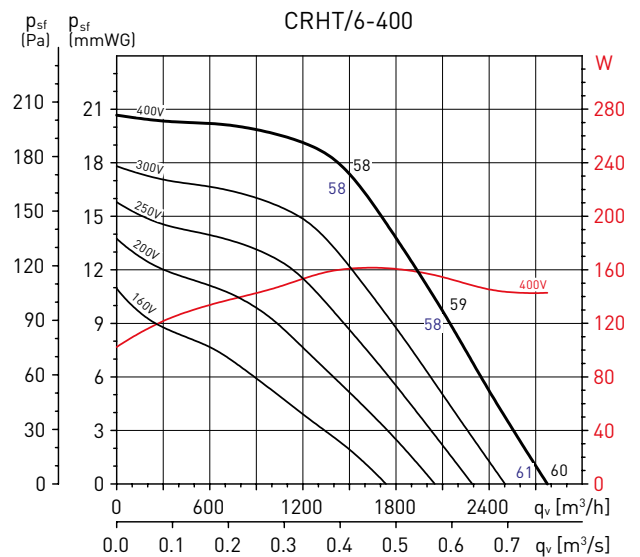
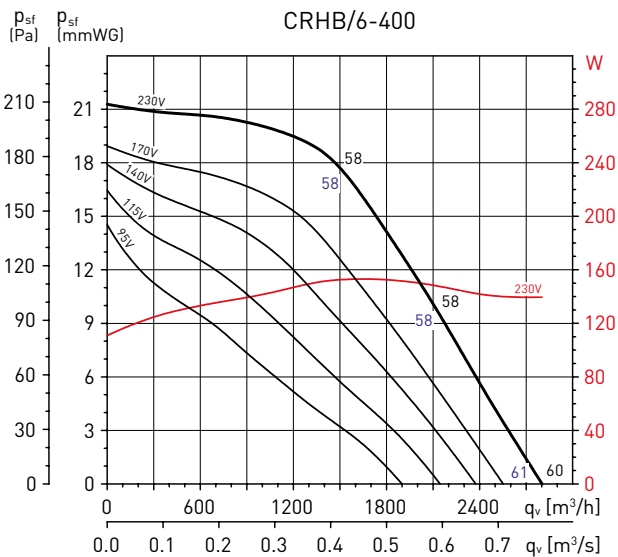
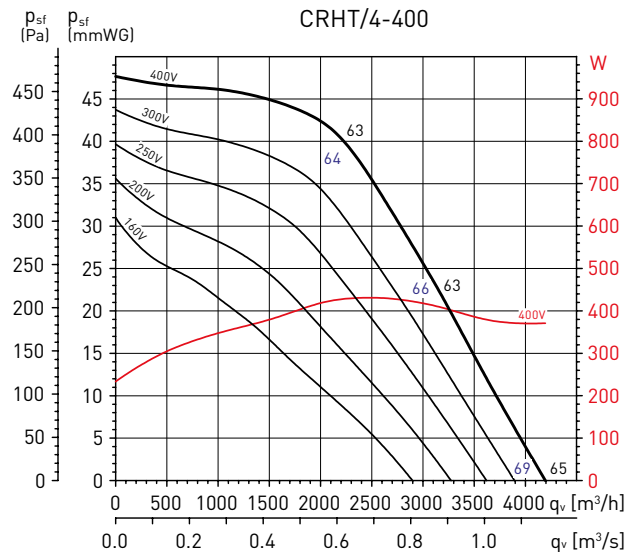
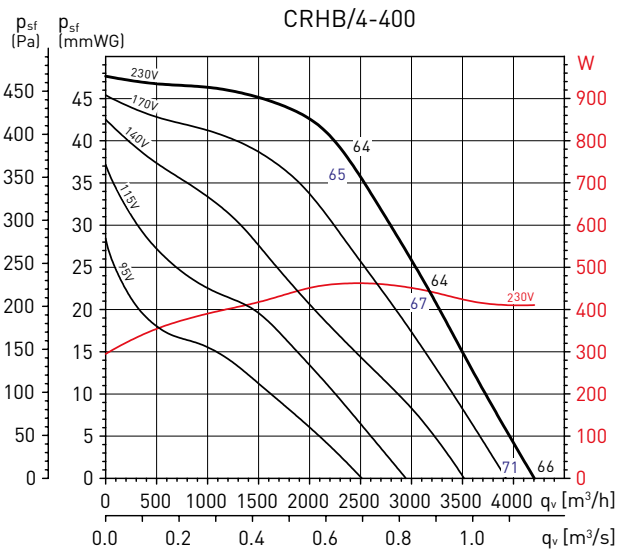
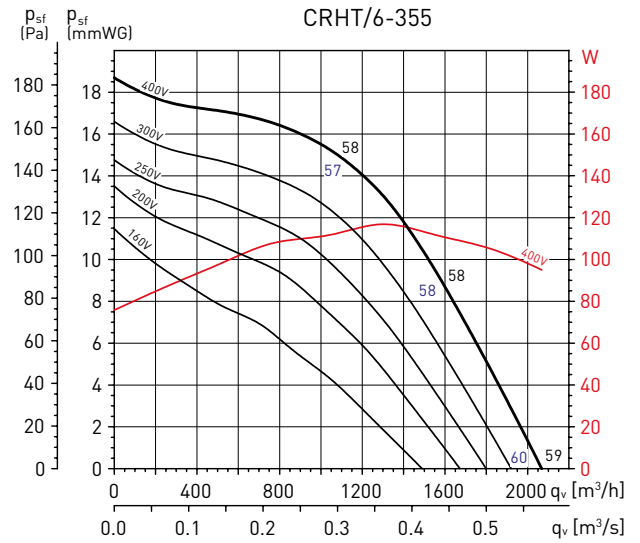
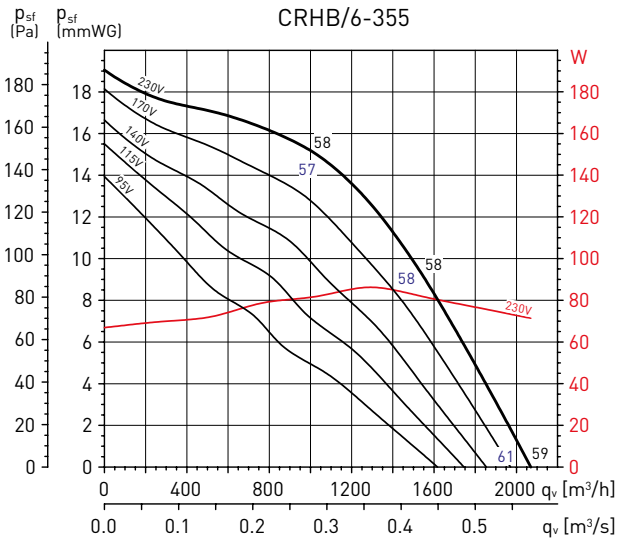

PERFORMANCE CURVES CRHB/CRHT

The values are sound pressure levels measured at 1,5 m, in free field conditions, at the fan inlet (black) and outlet (blue).

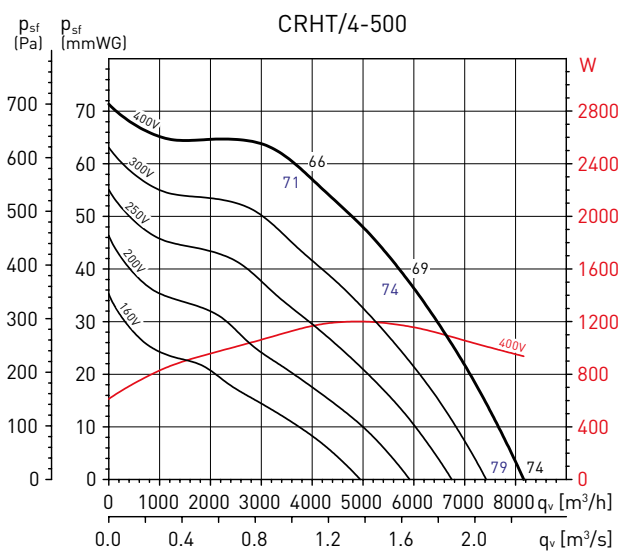
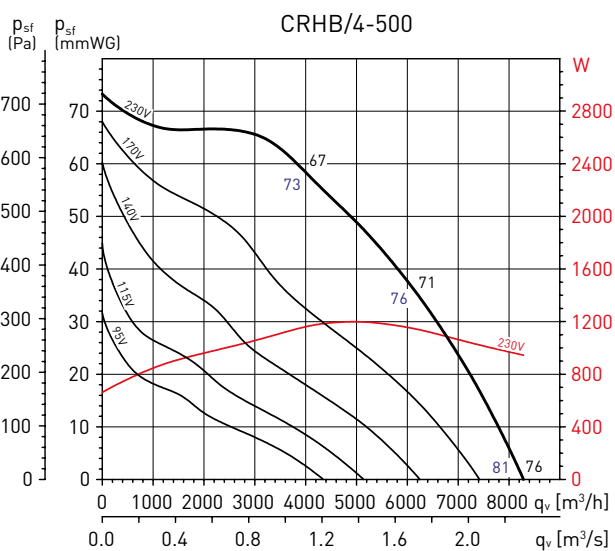
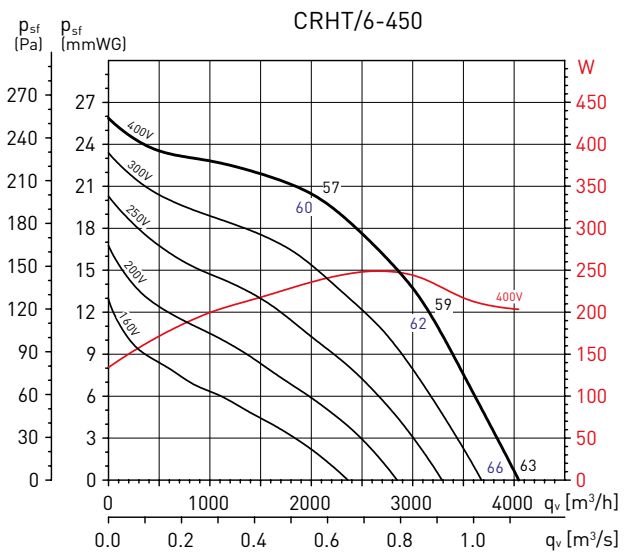
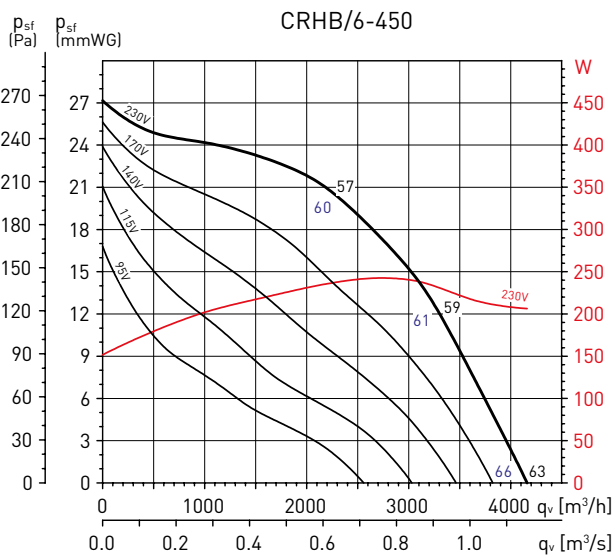
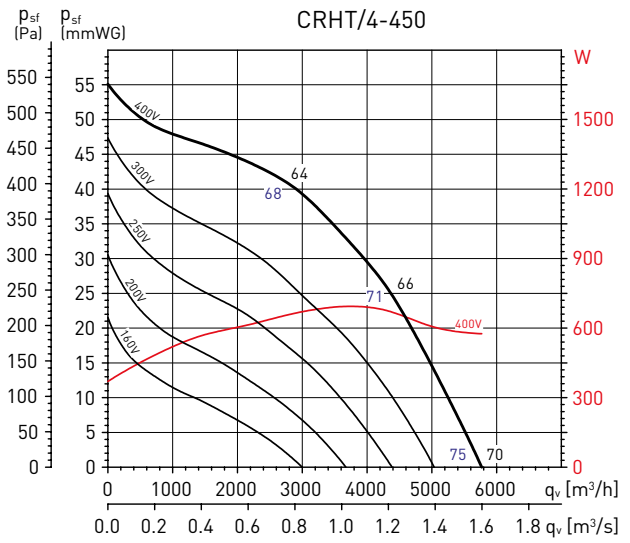
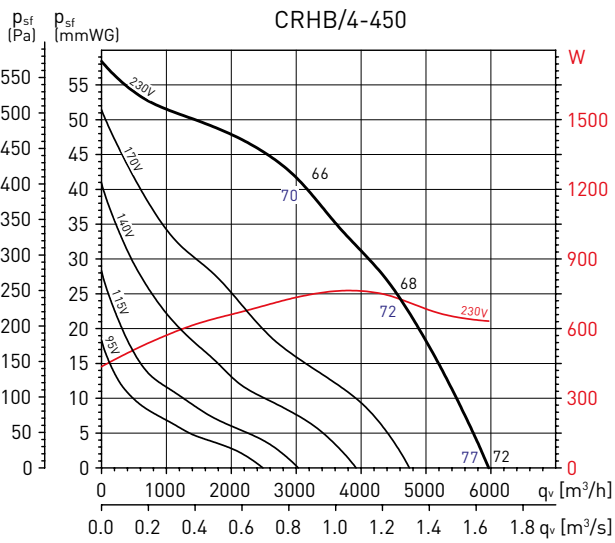

PERFORMANCE CURVES CRHB/CRHT

The values are sound pressure levels measured at 1,5 m, in free field conditions, at the fan inlet (black) and outlet (blue).

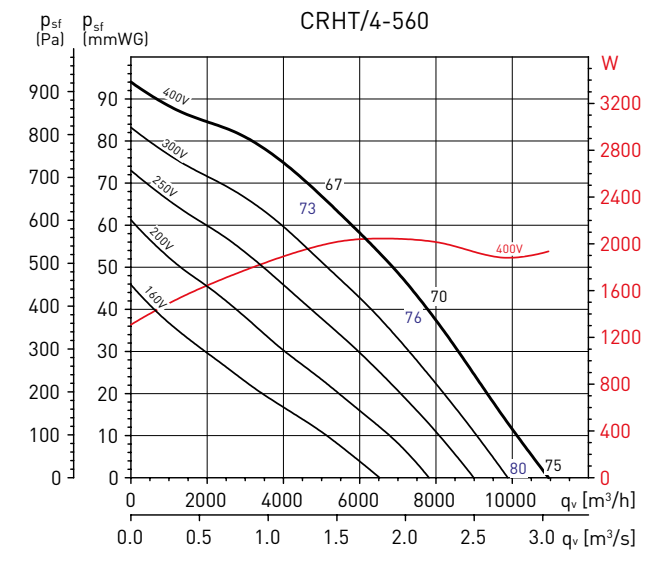
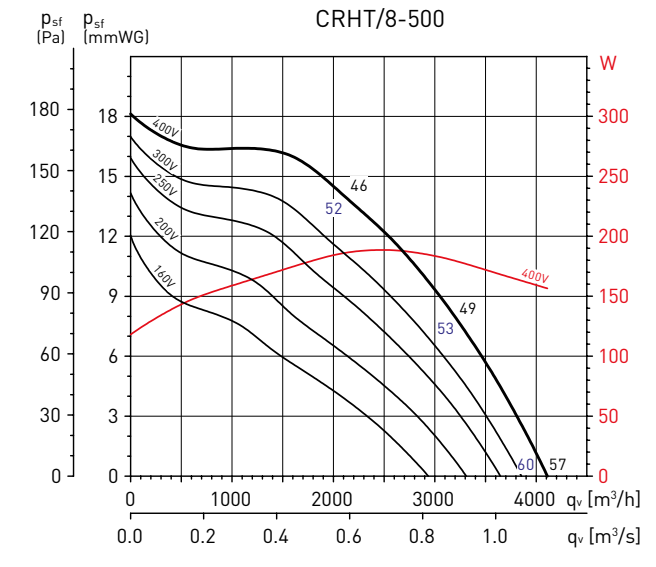
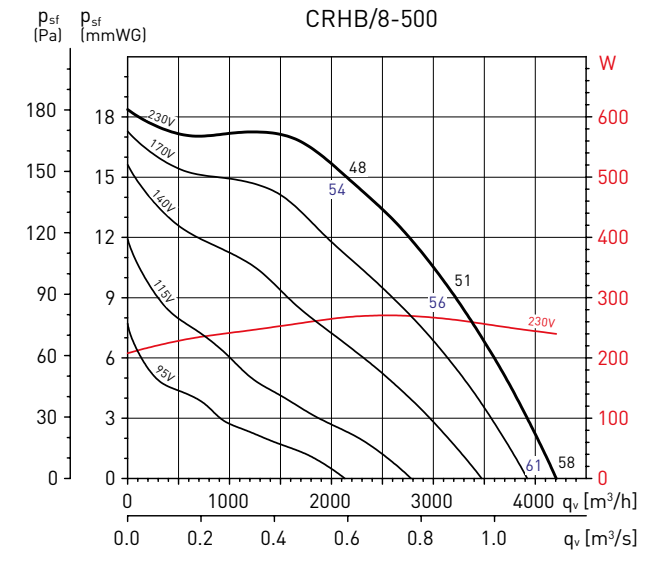
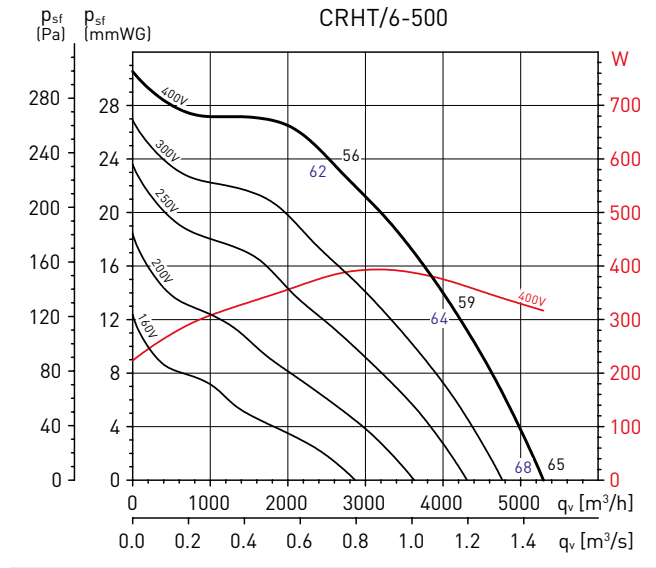
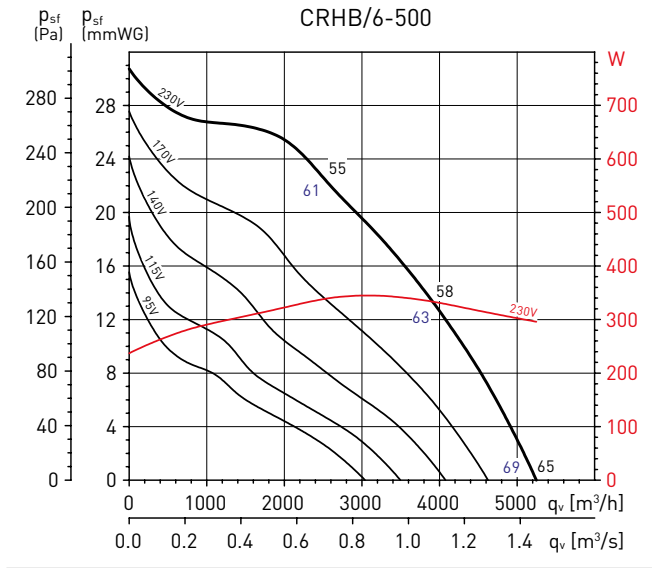

PERFORMANCE CURVES CRHB/CRHT

The values are sound pressure levels measured at 1,5 m, in free field conditions, at the fan inlet (black) and outlet (blue).

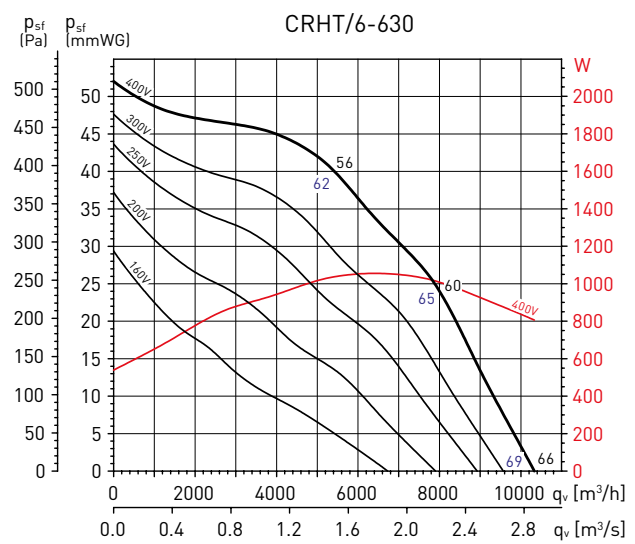
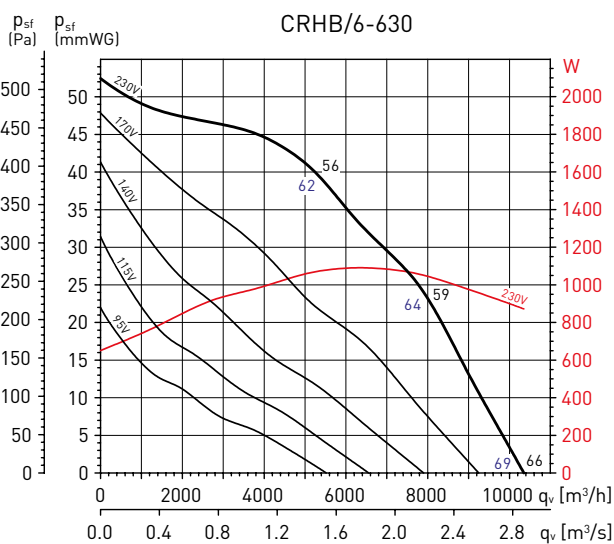
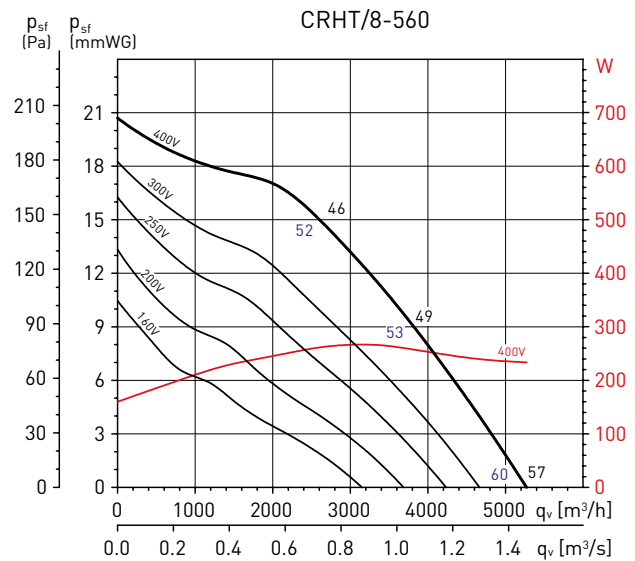
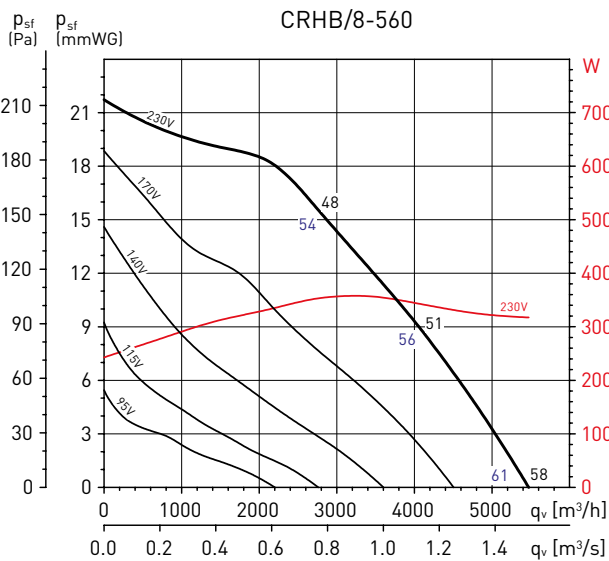
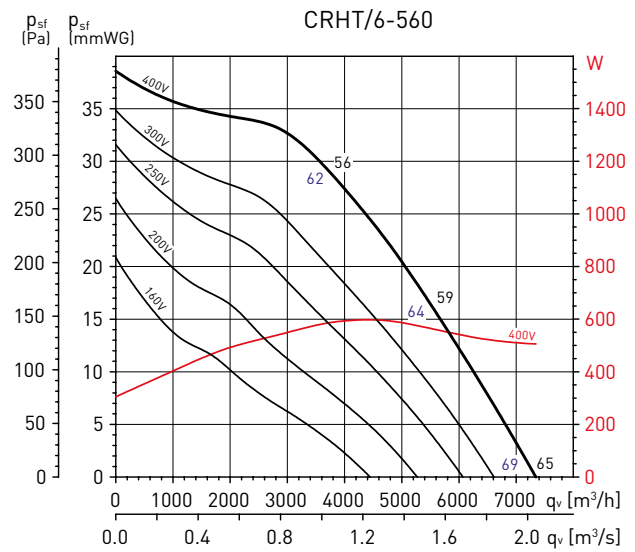
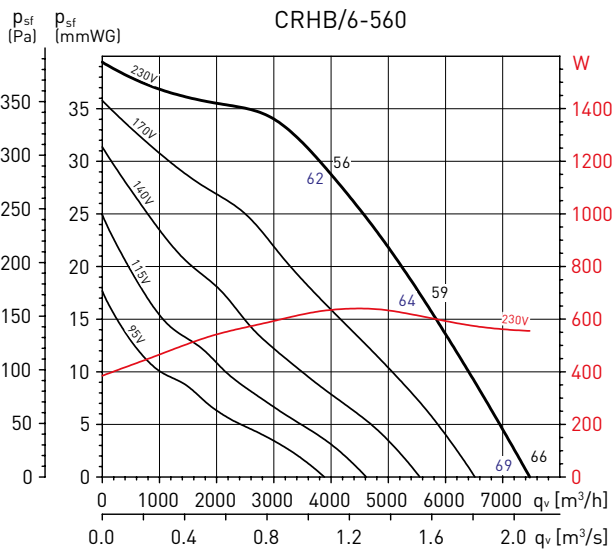

PERFORMANCE CURVES CRHB/CRHT

The values are sound pressure levels measured at 1,5 m, in free field conditions, at the fan inlet (black) and outlet (blue).

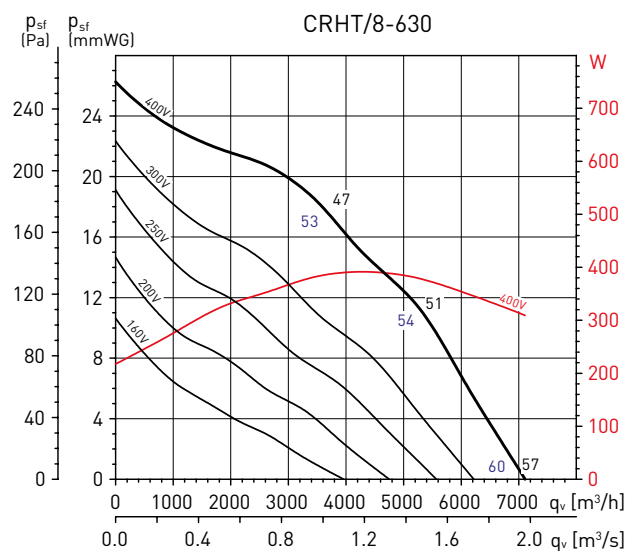
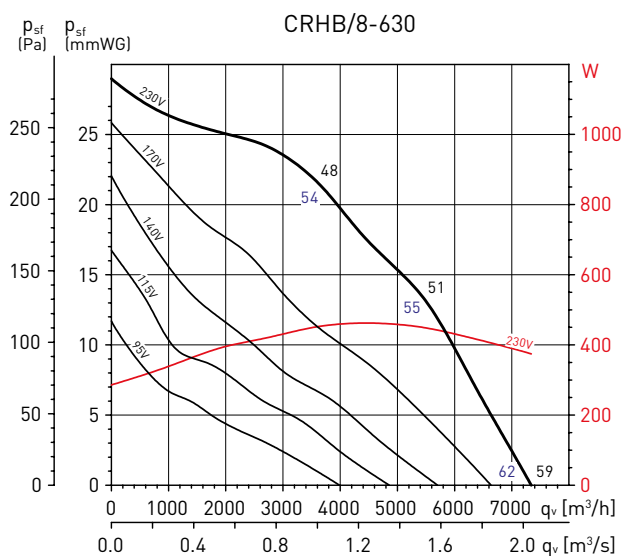

PERFORMANCE CURVES CRVB/CRVT

The values are sound pressure levels measured at 1,5 m, in free field conditions, at the fan inlet (black) and outlet (blue).

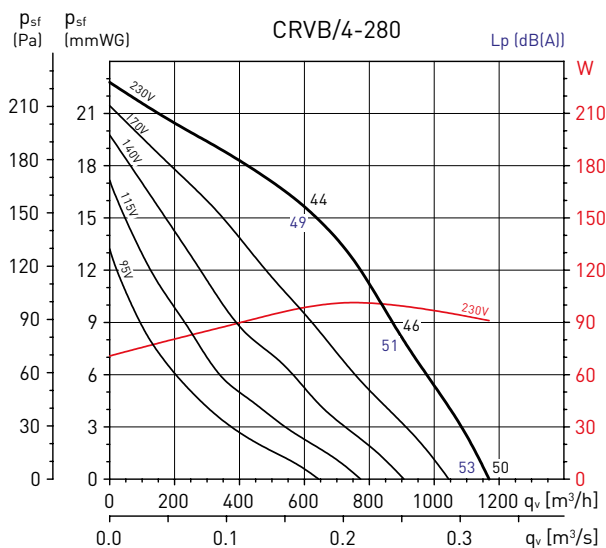
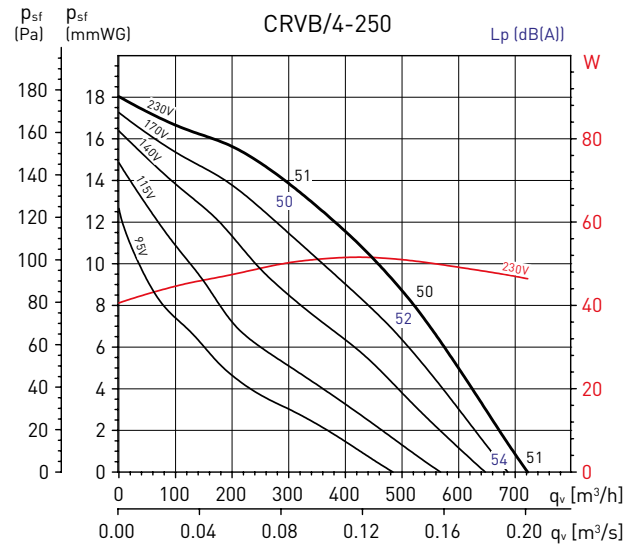
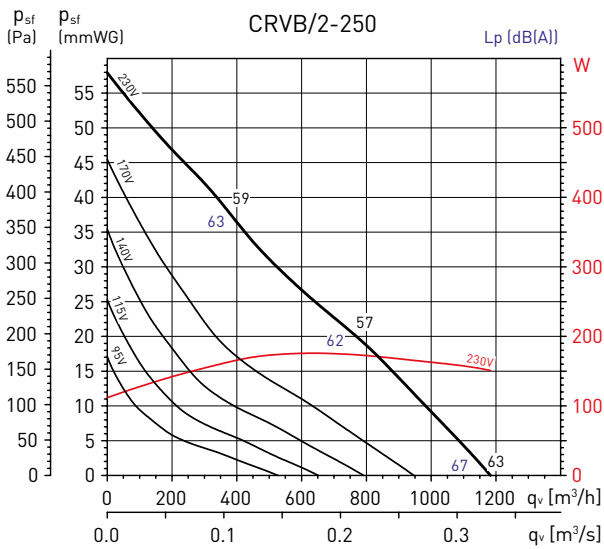
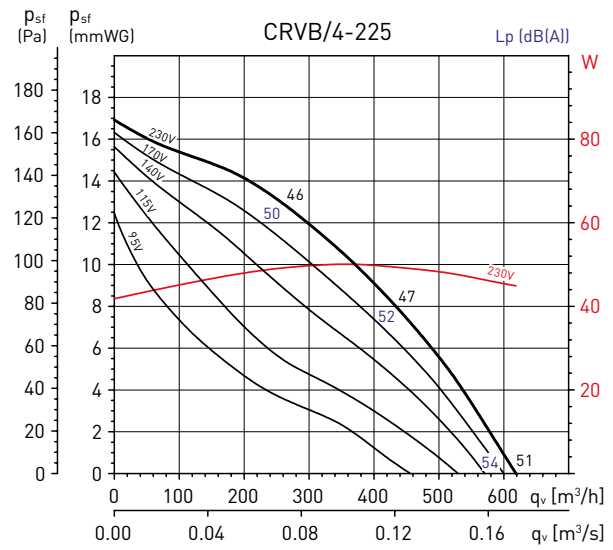
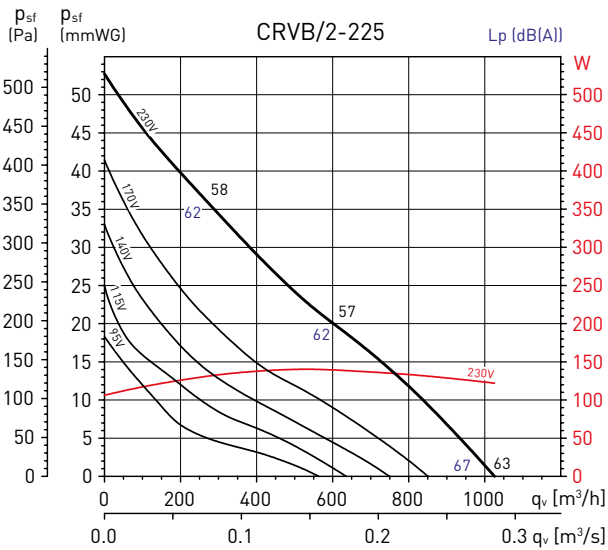

PERFORMANCE CURVES CRVB/CRVT

The values are sound pressure levels measured at 1,5 m, in free field conditions, at the fan inlet (black) and outlet (blue).

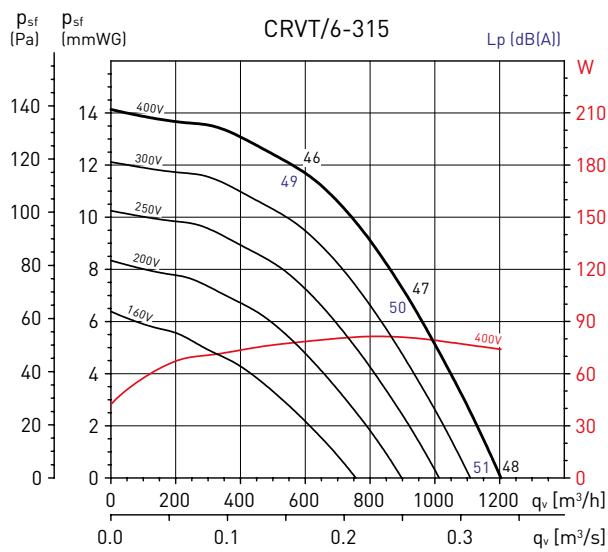
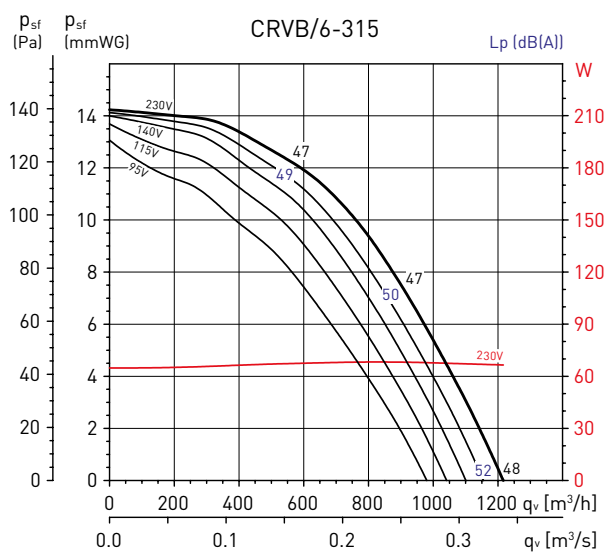
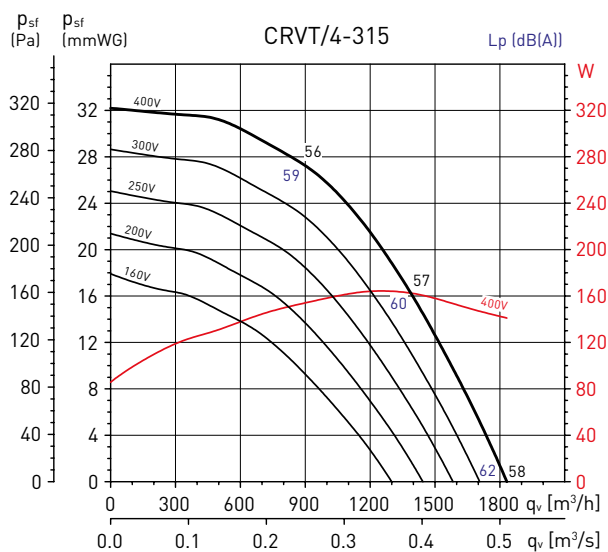
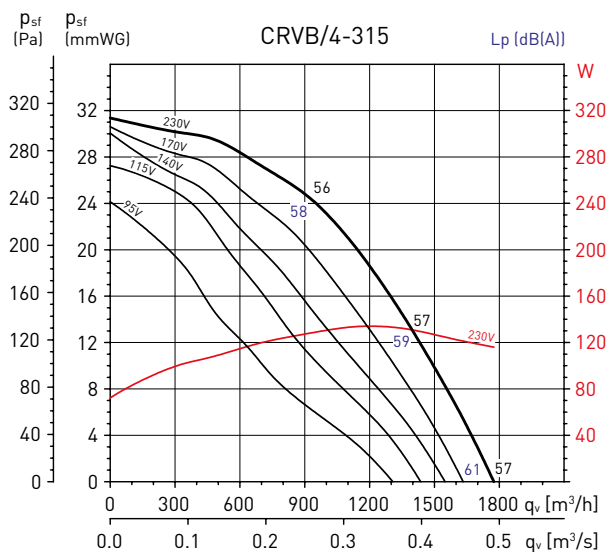

PERFORMANCE CURVES CRVB/CRVT

The values are sound pressure levels measured at 1,5 m, in free field conditions, at the fan inlet (black) and outlet (blue).

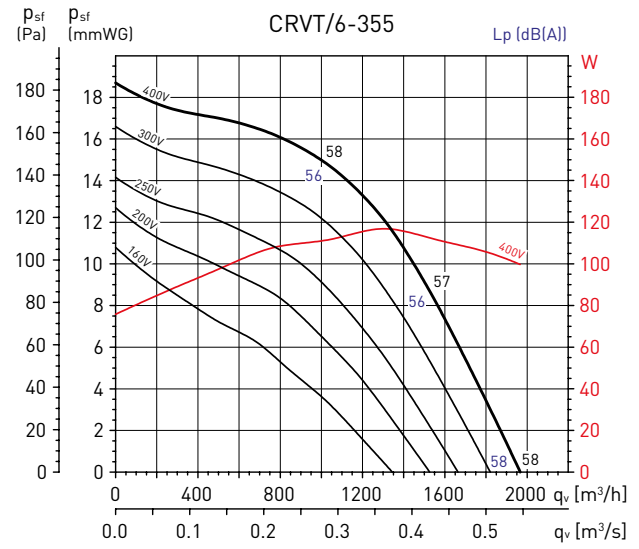
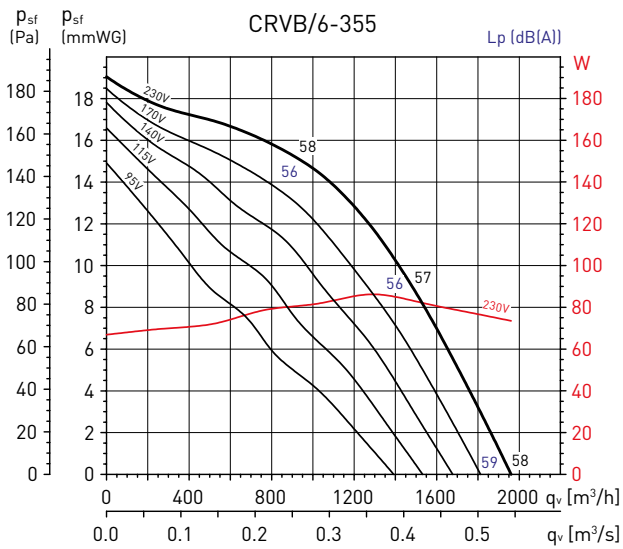
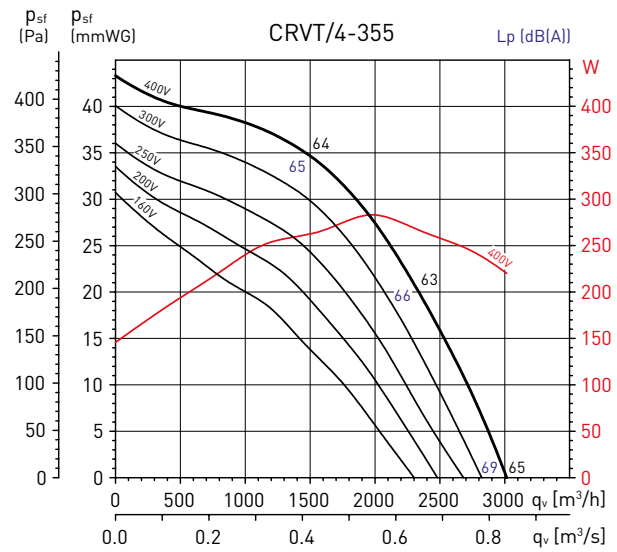
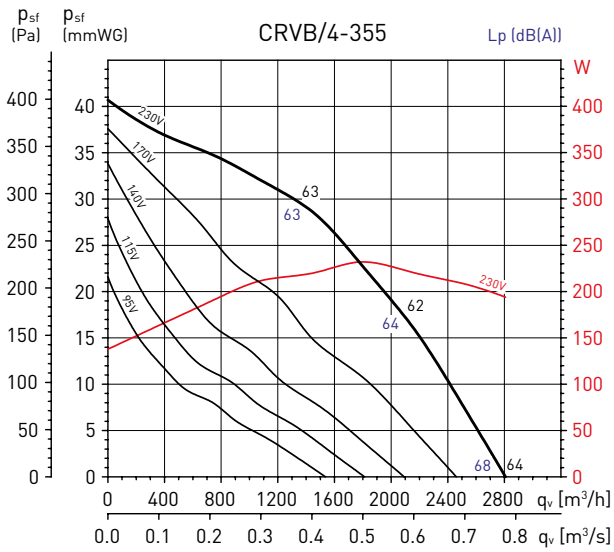

PERFORMANCE CURVES CRVB/CRVT

The values are sound pressure levels measured at 1,5 m, in free field conditions, at the fan inlet (black) and outlet (blue).

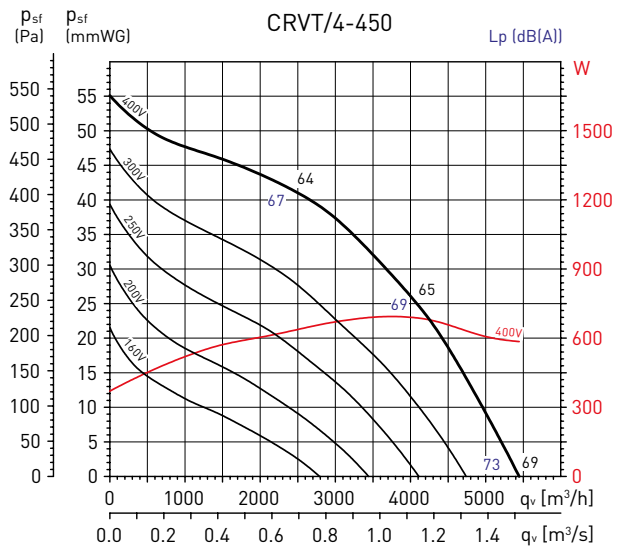
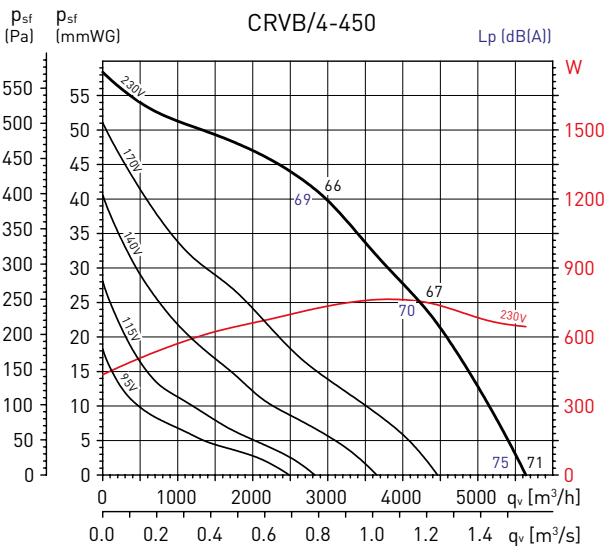
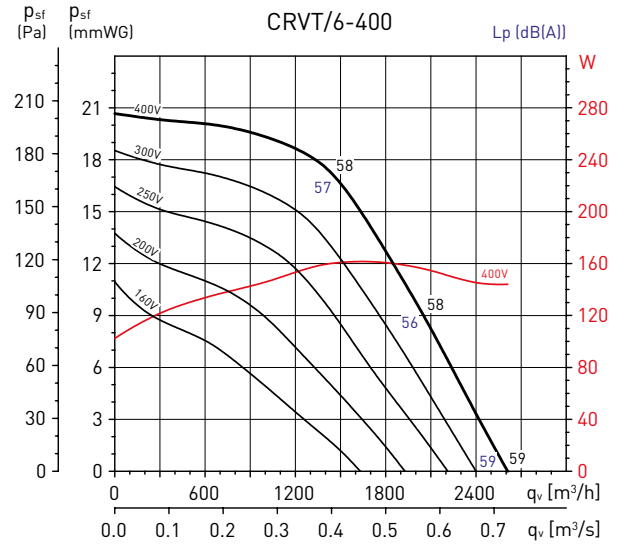
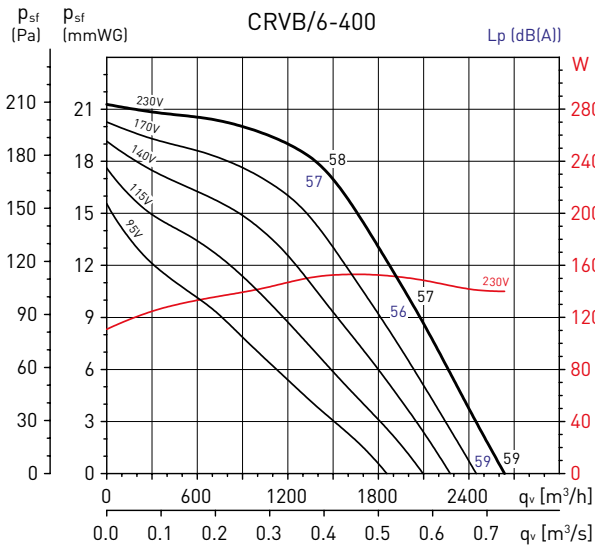
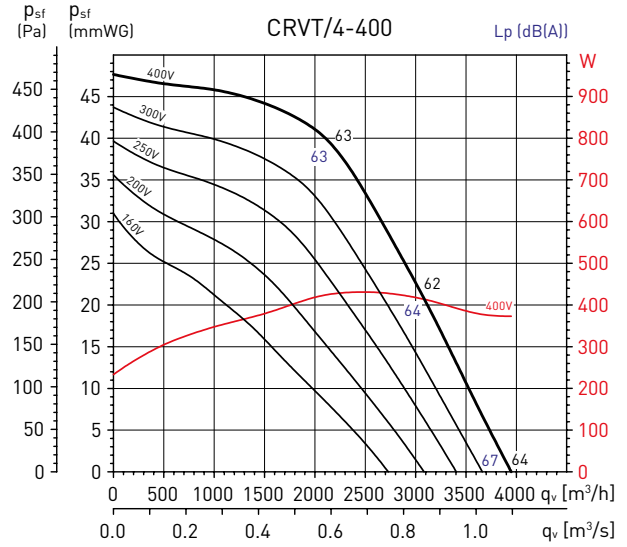
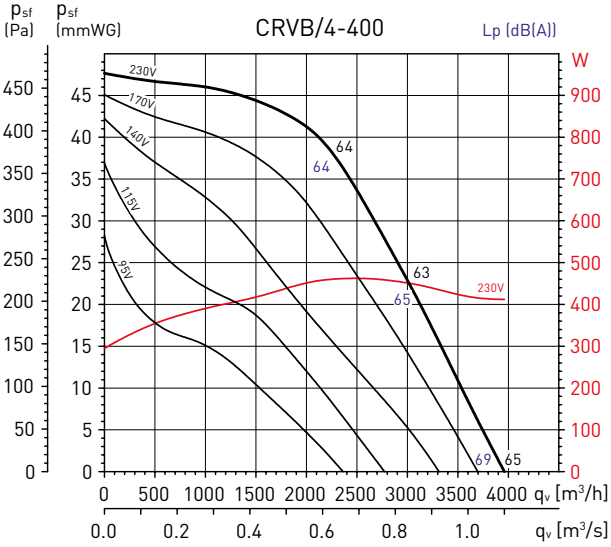

PERFORMANCE CURVES CRVB/CRVT

The values are sound pressure levels measured at 1,5 m, in free field conditions, at the fan inlet (black) and outlet (blue).

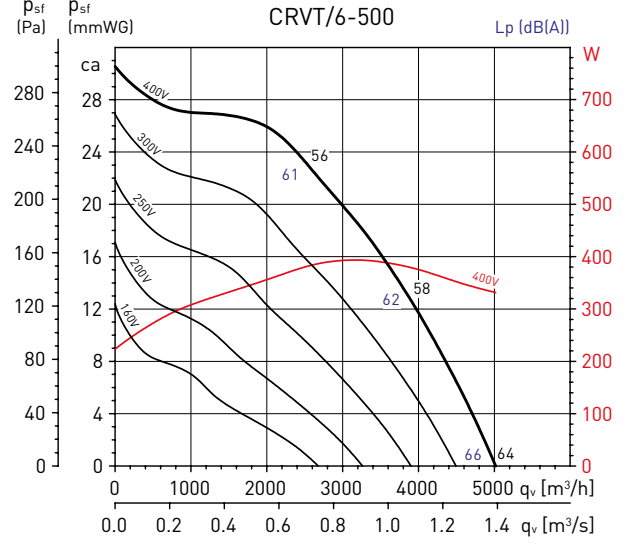
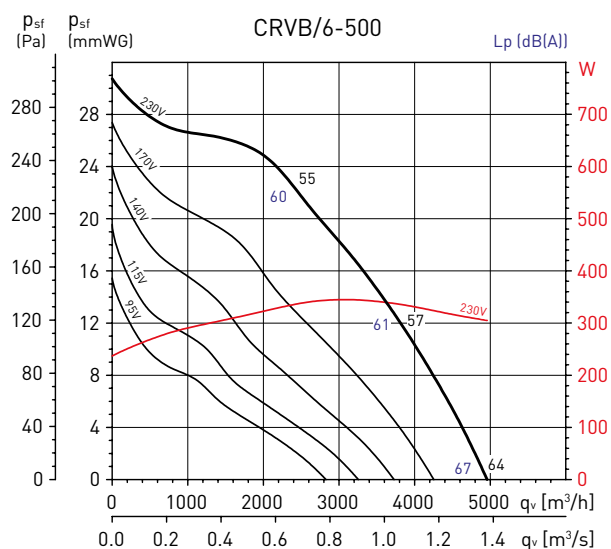
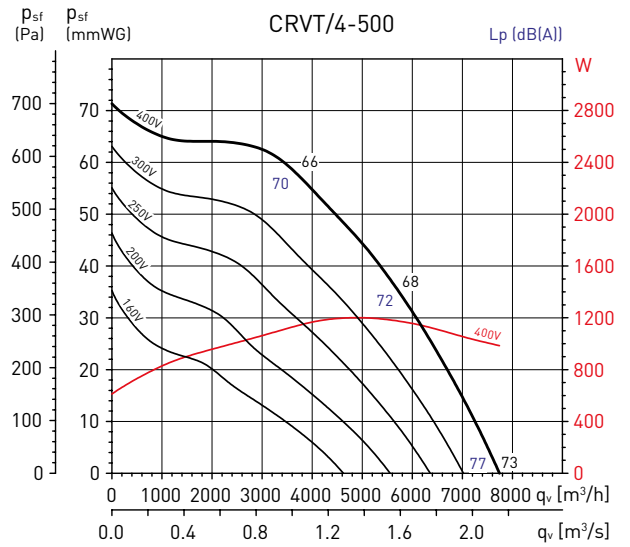
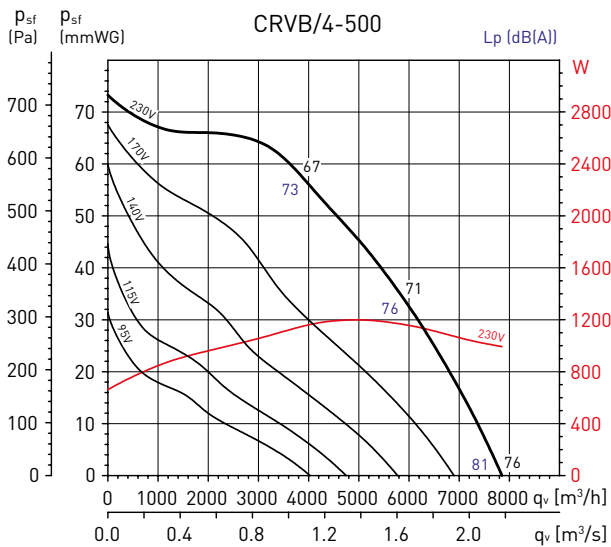
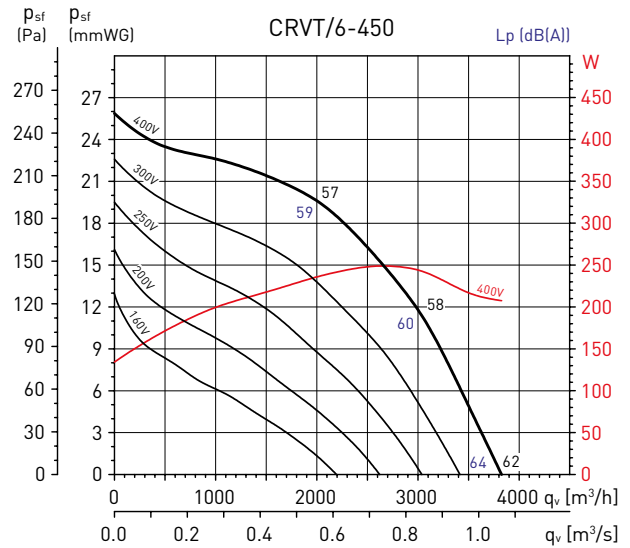
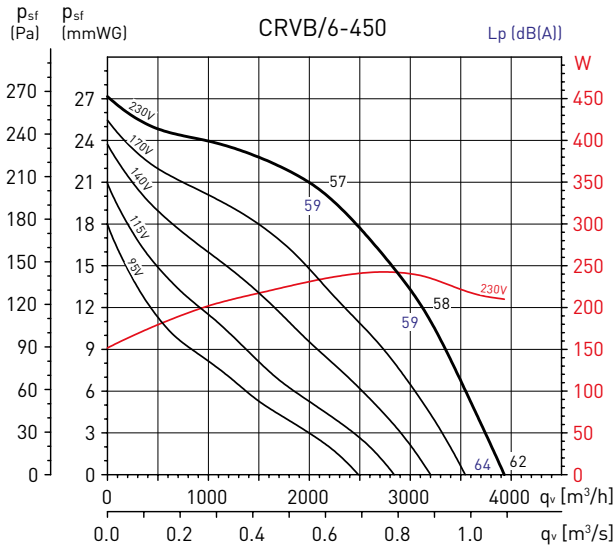

PERFORMANCE CURVES CRVB/CRVT

The values are sound pressure levels measured at 1,5 m, in free field conditions, at the fan inlet (black) and outlet (blue).

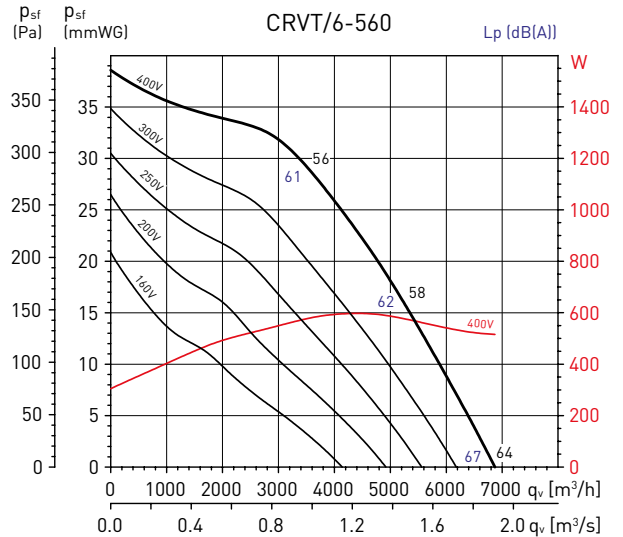
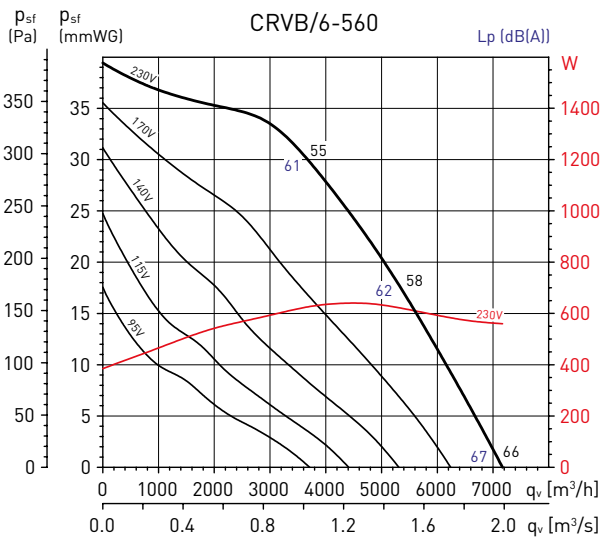
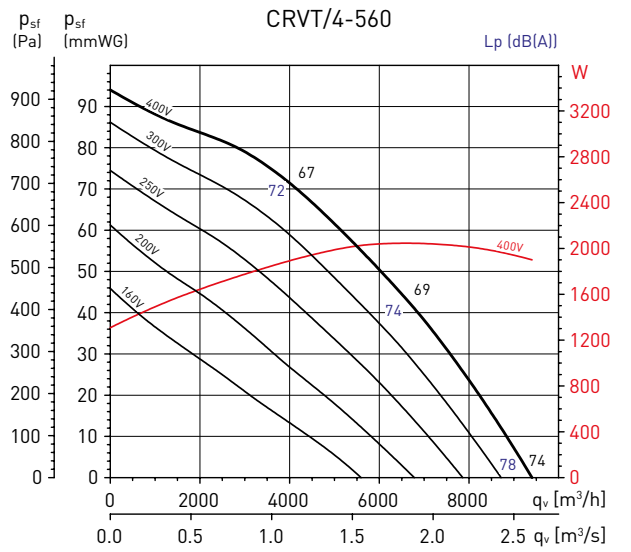
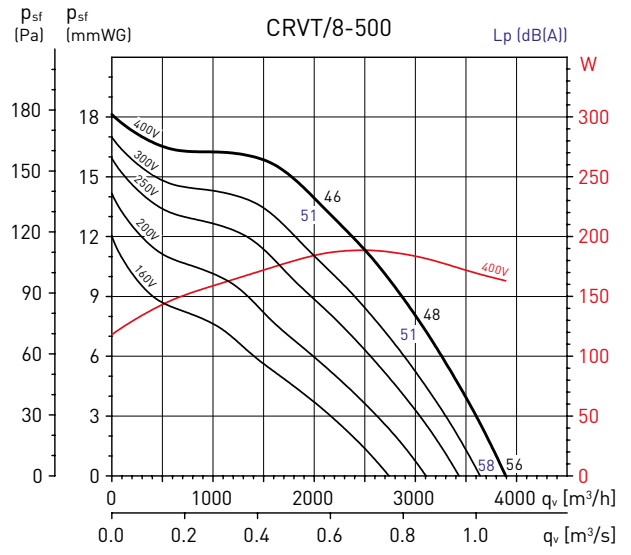
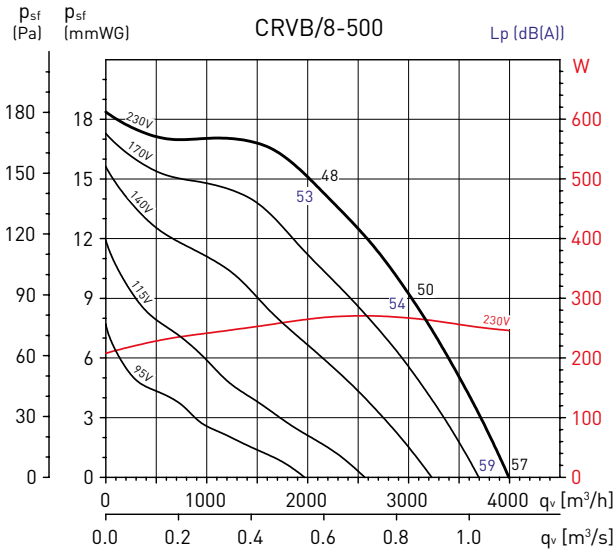

PERFORMANCE CURVES CRVB/CRVT

The values are sound pressure levels measured at 1,5 m, in free field conditions, at the fan inlet (black) and outlet (blue).

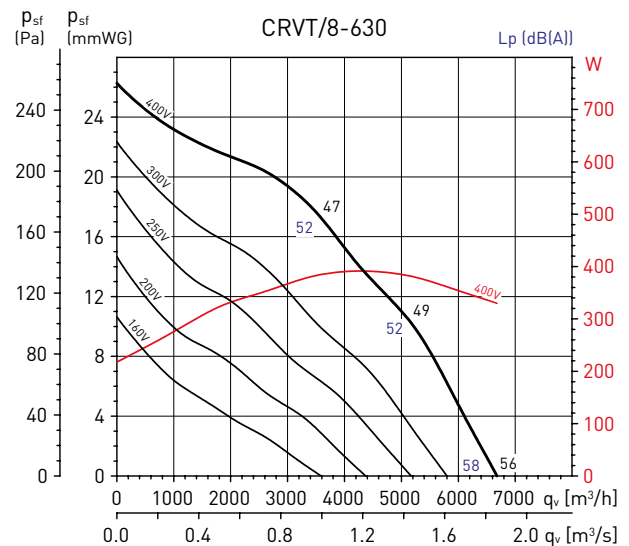
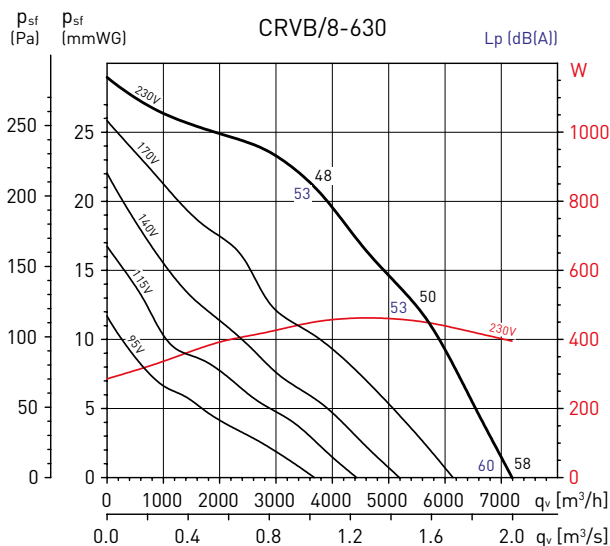
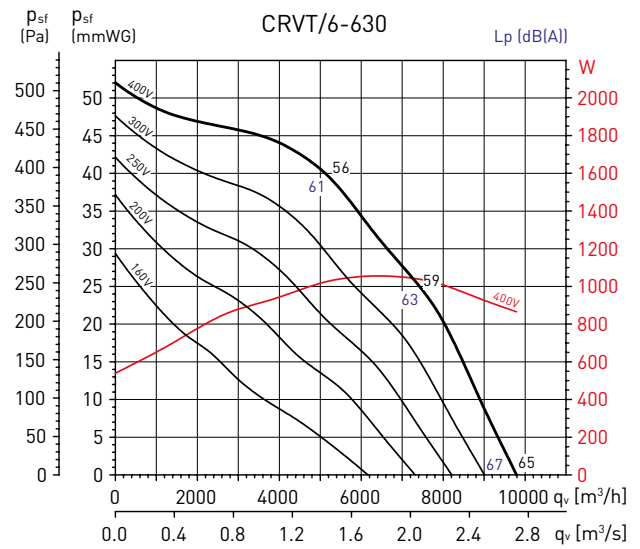
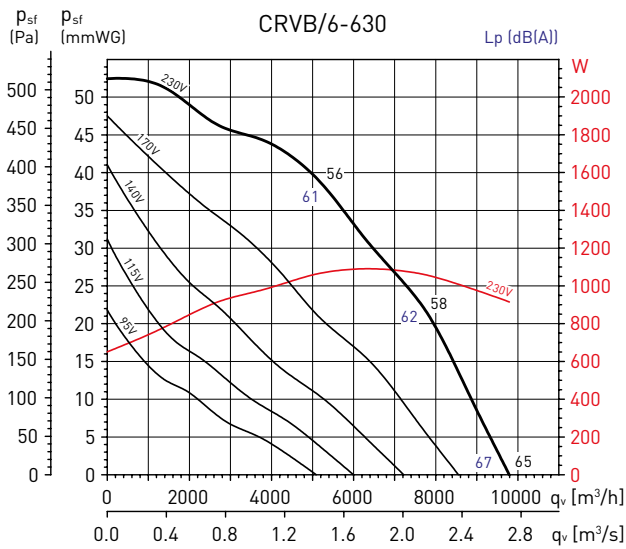
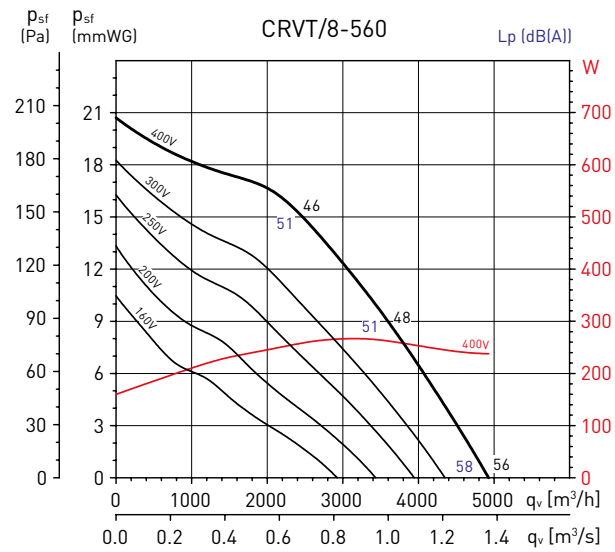
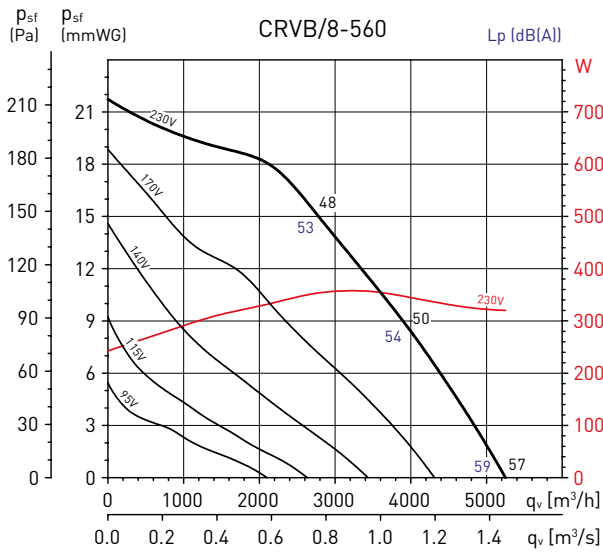

ACOUSTIC CHARACTERISTICS

Sound power spectrum in dB(A), at the fan inlet and outlet, at 3 working points of the performance curve (A: maximum airflow).

CRHB/2-225		63	125	250	500	1.000	2.000	4.000	8.000
Inlet	A	42	58	65	72	72	71	71	66
	B	39	53	60	66	66	65	66	59
	C	39	53	59	68	67	65	61	56
Outlet	A	45	60	67	74	77	78	78	69
	B	42	55	63	69	72	73	73	62
	C	40	54	62	68	71	72	72	62

CRHB/4-225		63	125	250	500	1.000	2.000	4.000	8.000
Inlet	A	39	48	57	60	60	60	60	51
	B	35	44	53	56	56	57	56	46
	C	34	42	51	56	55	52	49	43
Outlet	A	38	48	56	62	65	66	61	50
	B	37	46	55	60	63	64	59	48
	C	34	43	52	57	60	61	56	45

CRHB/2-250		63	125	250	500	1.000	2.000	4.000	8.000
Inlet	A	3	59	65	72	73	71	71	67
	B	40	53	61	66	66	65	67	60
	C	40	54	60	69	68	66	62	57
Outlet	A	45	61	68	74	77	78	78	70
	B	42	55	64	69	72	73	73	63
	C	41	55	63	69	72	73	73	63

CRHB/4-250		63	125	250	500	1.000	2.000	4.000	8.000
Inlet	A	39	48	57	60	60	60	60	51
	B	38	47	56	59	59	60	59	49
	C	39	47	57	61	60	58	54	49
Outlet	A	38	48	56	62	65	66	61	50
	B	36	46	55	60	63	64	59	48
	C	33	43	52	57	60	61	56	44

CRHB/4-280		63	125	250	500	1.000	2.000	4.000	8.000
Inlet	A	40	53	62	63	63	62	60	50
	B	39	52	61	62	62	62	59	49
	C	39	51	60	62	62	60	55	48
Outlet	A	41	54	62	66	69	69	63	52
	B	39	52	61	64	67	67	61	50
	C	37	50	58	62	64	64	58	47

CRHT/4-315		63	125	250	500	1.000	2.000	4.000	8.000
Inlet	A	41	59	67	67	67	64	60	50
	B	41	58	66	66	66	64	59	49
	C	39	56	64	64	64	62	57	47
Outlet	A	44	60	69	71	73	72	65	55
	B	42	59	67	69	71	70	63	53
	C	42	57	65	67	69	68	61	51

CRHB/4-315		63	125	250	500	1.000	2.000	4.000	8.000
Inlet	A	41	59	67	67	67	64	60	50
	B	41	58	66	66	66	64	59	49
	C	39	56	64	64	64	62	57	47
Outlet	A	44	60	69	71	73	72	65	55
	B	42	59	67	69	71	70	63	53
	C	42	57	65	67	69	68	61	51

CRHB/6-315		63	125	250	500	1.000	2.000	4.000	8.000
Inlet	A	38	53	57	58	58	55	48	38
	B	38	53	56	57	57	55	48	38
	C	36	50	54	56	55	53	46	36
Outlet	A	40	54	58	62	65	60	52	43
	B	38	52	56	61	63	58	51	41
	C	37	51	55	59	61	57	49	40

CRHT/6-315		63	125	250	500	1.000	2.000	4.000	8.000
Inlet	A	38	53	56	58	57	55	48	38
	B	38	53	56	57	57	55	48	38
	C	36	50	54	55	55	53	46	35
Outlet	A	40	54	58	62	64	60	52	43
	B	38	52	56	61	63	58	51	41
	C	37	51	55	59	61	57	49	40

CRHB/4-355		63	125	250	500	1.000	2.000	4.000	8.000
Inlet	A	47	62	67	71	71	73	76	67
	B	45	59	64	68	69	71	74	64
	C	45	59	64	68	69	71	74	64
Outlet	A	52	68	74	78	79	79	77	67
	B	48	64	69	73	75	74	73	62
	C	47	62	66	69	72	73	73	61

CRHT/4-355		63	125	250	500	1.000	2.000	4.000	8.000
Inlet	A	47	63	68	71	72	74	77	69
	B	45	61	66	69	70	72	75	67
	C	45	61	66	69	70	72	75	67
Outlet	A	53	70	75	79	80	80	78	69
	B	49	66	71	75	77	76	75	65
	C	48	64	68	71	74	75	75	64

CRHB/6-355		63	125	250	500	1.000	2.000	4.000	8.000
Inlet	A	43	55	60	64	65	69	70	52
	B	43	54	59	62	64	68	69	51
	C	42	53	58	62	64	68	68	50
Outlet	A	47	59	65	69	70	69	65	54
	B	44	56	62	66	67	67	62	51
	C	45	55	58	63	66	67	62	49

CRHT/6-355		63	125	250	500	1.000	2.000	4.000	8.000
Inlet	A	43	55	60	63	65	69	70	52
	B	43	54	59	62	64	68	69	51
	C	42	53	58	62	64	68	68	50
Outlet	A	47	59	64	68	70	69	64	53
	B	44	56	61	66	67	66	61	50
	C	45	55	58	63	66	67	62	49

ACOUSTIC CHARACTERISTICS

Sound power spectrum in dB(A), at the fan inlet and outlet, at 3 working points of the performance curve (A: maximum airflow).

CRHB/4-400		63	125	250	500	1.000	2.000	4.000	8.000
Inlet	A	47	63	67	71	72	74	77	68
	B	45	60	65	69	70	72	75	66
	C	45	60	65	69	70	72	75	66
Outlet	A	53	69	75	79	80	80	78	68
	B	49	65	71	75	76	76	74	64
	C	48	64	67	70	73	74	74	63

CRHT/4-400		63	125	250	500	1.000	2.000	4.000	8.000
Inlet	A	46	61	66	70	71	73	76	65
	B	45	59	64	68	69	71	74	64
	C	45	59	64	68	69	71	74	63
Outlet	A	52	67	73	77	78	78	76	66
	B	48	64	69	73	75	74	73	62
	C	47	62	66	69	72	73	73	61

CRHB/6-400		63	125	250	500	1.000	2.000	4.000	8.000
Inlet	A	43	55	60	64	65	69	71	53
	B	43	54	59	62	64	68	69	51
	C	42	54	59	62	64	68	69	51
Outlet	A	47	59	65	69	70	70	65	54
	B	44	56	62	66	67	67	62	51
	C	45	55	59	64	67	68	63	50

CRHT/6-400		63	125	250	500	1.000	2.000	4.000	8.000
Inlet	A	43	55	60	64	65	69	71	53
	B	42	54	59	63	64	68	70	52
	C	42	54	59	62	64	68	69	51
Outlet	A	47	60	65	69	71	70	66	55
	B	44	57	62	66	68	67	63	52
	C	45	55	59	64	67	68	63	50

CRHB/4-450		63	125	250	500	1.000	2.000	4.000	8.000
Inlet	A	54	73	77	80	81	79	80	78
	B	54	70	74	76	76	74	72	68
	C	53	67	71	73	73	71	68	63
Outlet	A	58	77	83	85	85	84	85	83
	B	57	74	78	81	82	80	78	74
	C	54	71	75	78	79	77	75	71

CRHT/4-450		63	125	250	500	1.000	2.000	4.000	8.000
Inlet	A	53	72	76	79	79	78	79	75
	B	52	68	72	74	74	72	71	65
	C	52	66	69	72	71	69	66	61
Outlet	A	57	77	81	83	82	83	83	81
	B	55	72	76	79	80	78	76	72
	C	53	69	73	77	77	76	73	69

CRHB/6-450		63	125	250	500	1.000	2.000	4.000	8.000
Inlet	A	52	62	66	69	69	69	72	60
	B	49	57	61	63	63	61	63	46
	C	47	55	59	61	61	59	55	50
Outlet	A	53	66	70	72	73	74	74	63
	B	50	61	65	68	69	68	65	55
	C	50	59	63	66	67	65	63	53

CRHT/6-450		63	125	250	500	1.000	2.000	4.000	8.000
Inlet	A	52	62	66	69	69	69	72	60
	B	50	58	62	64	64	62	64	47
	C	47	56	59	62	61	59	56	51
Outlet	A	53	66	70	72	72	74	74	63
	B	52	61	66	69	70	68	66	56
	C	50	59	64	67	67	66	64	54

CRHB/4-500		63	125	250	500	1.000	2.000	4.000	8.000
Inlet	A	57	76	80	83	84	82	83	81
	B	57	73	77	79	79	77	75	71
	C	56	70	74	76	76	74	71	66
Outlet	A	61	80	86	88	88	87	88	86
	B	60	77	81	84	85	83	81	77
	C	57	74	78	81	82	80	78	74

CRHT/4-500		63	125	250	500	1.000	2.000	4.000	8.000
Inlet	A	56	75	79	82	82	81	82	78
	B	55	71	75	77	77	75	74	68
	C	55	69	72	75	74	72	69	64
Outlet	A	60	80	84	86	85	86	86	84
	B	58	75	79	82	83	81	79	75
	C	56	72	76	80	80	79	76	72

CRHB/6-500		63	125	250	500	1.000	2.000	4.000	8.000
Inlet	A	55	65	69	72	72	72	75	63
	B	52	60	64	66	66	64	66	49
	C	50	58	62	64	64	62	58	53
Outlet	A	56	69	73	75	76	77	77	66
	B	55	64	68	71	72	71	68	58
	C	53	62	66	69	70	68	66	56

CRHT/6-500		63	125	250	500	1.000	2.000	4.000	8.000
Inlet	A	55	65	69	72	72	72	75	63
	B	53	61	65	67	67	65	67	50
	C	50	59	62	65	64	62	59	54
Outlet	A	56	69	73	75	75	77	77	66
	B	55	64	69	72	73	71	69	59
	C	53	62	67	70	70	69	67	57

CRHB/8-500		63	125	250	500	1.000	2.000	4.000	8.000
Inlet	A	50	58	62	65	66	67	66	53
	B	47	54	57	60	59	59	56	37
	C	44	51	54	57	56	54	51	46
Outlet	A	53	61	64	67	68	70	70	52
	B	49	56	61	64	64	63	61	47
	C	47	54	59	62	63	61	59	45

CRHT/8-500		63	125	250	500	1.000	2.000	4.000	8.000
Inlet	A	49	57	61	64	64	67	64	51
	B	44	51	55	57	57	58	52	33
	C	42	49	52	55	55	52	49	44
Outlet	A	53	59	63	65	67	69	68	49
	B	46	54	59	62	62	61	57	43
	C	45	53	57	60	61	60	56	42

ACOUSTIC CHARACTERISTICS

Sound power spectrum in dB(A), at the fan inlet and outlet, at 3 working points of the performance curve (A: maximum airflow).

CRHB/6-560		63	125	250	500	1.000	2.000	4.000	8.000
Inlet	A	55	65	70	73	73	72	75	64
	B	53	62	65	68	67	65	67	51
	C	50	59	63	65	65	63	60	54
Outlet	A	57	70	74	76	76	77	78	67
	B	55	65	69	73	73	72	69	60
	C	53	63	67	70	71	69	67	57

CRHB/8-560		63	125	250	500	1.000	2.000	4.000	8.000
Inlet	A	51	59	63	66	66	68	67	54
	B	46	53	57	59	59	59	55	36
	C	44	51	54	57	56	54	51	46
Outlet	A	53	61	65	67	69	70	71	53
	B	48	56	60	64	64	63	60	46
	C	47	54	59	62	63	61	59	45

CRHB/6-630		63	125	250	500	1.000	2.000	4.000	8.000
Inlet	A	55	66	70	73	73	72	76	64
	B	53	62	65	68	67	65	67	51
	C	50	59	63	65	65	63	60	55
Outlet	A	57	70	74	76	76	78	78	68
	B	55	65	69	73	73	72	69	60
	C	53	63	67	71	71	70	67	58

CRHB/8-630		63	125	250	500	1.000	2.000	4.000	8.000
Inlet	A	52	60	64	67	67	69	69	55
	B	49	56	59	62	61	60	59	40
	C	46	53	57	59	59	57	54	49
Outlet	A	54	63	66	69	70	72	72	55
	B	51	58	63	66	67	65	63	50
	C	49	57	61	65	65	64	61	49

CRHT/4-560		63	125	250	500	1.000	2.000	4.000	8.000
Inlet	A	57	76	80	83	83	82	82	80
	B	56	73	76	79	78	76	75	70
	C	56	70	74	76	76	74	71	65
Outlet	A	61	80	85	88	87	87	87	86
	B	59	76	81	84	84	83	81	76
	C	57	73	78	81	82	80	78	73

CRHT/6-560		63	125	250	500	1.000	2.000	4.000	8.000
Inlet	A	55	65	69	72	73	72	75	64
	B	53	61	65	67	67	65	67	50
	C	50	59	62	65	64	62	59	54
Outlet	A	56	70	73	75	76	77	77	67
	B	55	64	69	72	73	71	69	59
	C	53	62	67	70	70	69	67	57

CRHT/8-560		63	125	250	500	1.000	2.000	4.000	8.000
Inlet	A	49	57	61	64	64	67	64	51
	B	44	51	55	57	57	58	52	33
	C	42	49	52	55	55	52	49	44
Outlet	A	53	59	63	65	67	69	68	49
	B	46	54	59	62	62	61	57	43
	C	45	53	57	60	61	60	56	42

CRHT/6-630		63	125	250	500	1.000	2.000	4.000	8.000
Inlet	A	55	66	70	73	73	72	76	64
	B	53	62	66	68	68	66	68	52
	C	50	59	63	65	65	63	60	55
Outlet	A	57	70	74	76	76	78	78	68
	B	55	65	70	73	73	72	70	60
	C	53	63	67	71	71	70	67	58

CRHT/8-630		63	125	250	500	1.000	2.000	4.000	8.000
Inlet	A	52	59	63	66	67	68	68	55
	B	48	55	59	61	61	60	58	39
	C	46	52	56	59	58	56	53	48
Outlet	A	54	62	66	68	70	71	71	55
	B	50	58	62	65	66	65	62	49
	C	49	56	61	64	64	63	61	48

ACOUSTIC CHARACTERISTICS

Sound power spectrum in dB(A), at the fan inlet and outlet, at 3 working points of the performance curve (A: maximum airflow).

CRVB/2-225		63	125	250	500	1.000	2.000	4.000	8.000
Inlet	A	41	57	64	71	71	70	70	65
	B	38	52	59	65	65	64	65	58
	C	39	53	59	68	67	65	61	56
Outlet	A	43	58	65	72	75	76	76	67
	B	40	53	61	67	70	71	71	60
	C	39	53	61	67	70	71	71	61

CRVB/4-225		63	125	250	500	1.000	2.000	4.000	8.000
Inlet	A	38	47	56	59	59	59	59	50
	B	34	43	52	55	55	56	55	45
	C	34	42	51	56	55	52	49	43
Outlet	A	36	46	54	60	63	64	59	48
	B	35	44	53	58	61	62	57	46
	C	33	42	51	56	59	60	55	44

CRVB/2-250		63	125	250	500	1.000	2.000	4.000	8.000
Inlet	A	42	58	64	71	72	70	70	66
	B	39	52	60	65	65	64	66	59
	C	40	54	60	69	68	66	62	57
Outlet	A	43	59	66	72	75	76	76	68
	B	40	53	62	67	70	71	71	61
	C	40	54	62	68	71	72	72	62

CRVB/4-250		63	125	250	500	1.000	2.000	4.000	8.000
Inlet	A	38	47	56	59	59	59	59	50
	B	37	46	55	58	58	59	58	48
	C	39	47	57	61	60	58	54	49
Outlet	A	36	46	54	60	63	64	59	48
	B	34	44	53	58	61	62	57	46
	C	31	42	51	56	59	60	55	43

CRVB/4-280		63	125	250	500	1.000	2.000	4.000	8.000
Inlet	A	39	52	61	62	62	61	59	49
	B	38	51	60	61	61	61	58	48
	C	39	51	60	62	62	60	55	48
Outlet	A	39	52	60	64	67	67	61	50
	B	37	50	59	62	65	65	59	48
	C	35	49	57	61	63	63	57	46

CRVT/4-315		63	125	250	500	1.000	2.000	4.000	8.000
Inlet	A	40	58	67	67	66	64	60	50
	B	40	57	66	66	66	63	59	49
	C	39	56	65	65	65	62	58	48
Outlet	A	42	59	68	70	72	71	63	54
	B	41	57	66	68	70	69	62	52
	C	39	56	65	67	69	68	61	51

CRVB/6-315		63	125	250	500	1.000	2.000	4.000	8.000
Inlet	A	52	56	57	57	54	47	37	
	B	37	52	55	56	56	54	47	37
	C	36	50	54	56	55	53	46	36
Outlet	A	38	52	56	60	63	58	50	41
	B	36	50	54	59	61	56	49	39
	C	36	50	54	58	60	56	48	39

CRVT/6-315		63	125	250	500	1.000	2.000	4.000	8.000
Inlet	A	37	52	55	57	56	54	47	37
	B	37	52	55	56	56	54	47	37
	C	36	50	54	55	55	53	46	35
Outlet	A	38	52	56	60	62	58	50	41
	B	36	50	54	59	61	56	49	39
	C	36	50	54	58	60	56	48	39

CRVB/4-355		63	125	250	500	1.000	2.000	4.000	8.000
Inlet	A	46	61	66	70	70	72	75	66
	B	44	58	63	67	68	70	73	63
	C	45	59	64	68	69	71	74	64
Outlet	A	50	66	72	76	77	77	75	65
	B	46	62	67	71	73	72	71	60
	C	46	61	65	68	71	72	72	60

CRVT/4-355		63	125	250	500	1.000	2.000	4.000	8.000
Inlet	A	46	62	67	70	71	73	76	68
	B	44	60	65	68	69	71	74	66
	C	45	61	66	69	70	72	75	67
Outlet	A	51	68	73	77	78	78	76	67
	B	47	64	69	73	75	74	73	63
	C	47	63	67	70	73	74	74	63

CRVB/6-355		63	125	250	500	1.000	2.000	4.000	8.000
Inlet	A	42	54	59	63	64	68	69	51
	B	42	53	58	61	63	67	68	50
	C	42	53	58	62	64	68	68	50
Outlet	A	45	57	63	67	68	67	63	52
	B	42	54	60	64	65	65	60	49
	C	44	54	57	62	65	66	61	48

CRVT/6-355		63	125	250	500	1.000	2.000	4.000	8.000
Inlet	A	42	54	59	62	64	68	69	51
	B	42	53	58	61	63	67	68	50
	C	42	53	58	62	64	68	68	50
Outlet	A	45	57	62	66	68	67	62	51
	B	42	54	59	64	65	64	59	48
	C	44	54	57	62	65	66	61	48

ACOUSTIC CHARACTERISTICS

Sound power spectrum in dB(A), at the fan inlet and outlet, at 3 working points of the performance curve (A: maximum airflow).

CRVB/4-400		63	125	250	500	1.000	2.000	4.000	8.000
Inlet	A	46	62	66	70	71	73	76	67
	B	44	59	64	68	69	71	74	65
	C	45	60	65	69	70	72	75	66
Outlet	A	51	67	73	77	78	78	76	66
	B	47	63	69	73	74	74	72	62
	C	47	63	66	69	72	73	73	62

CRVT/4-400		63	125	250	500	1.000	2.000	4.000	8.000
Inlet	A	45	60	65	69	70	72	75	64
	B	44	58	63	67	68	70	73	63
	C	45	59	64	68	69	71	74	63
Outlet	A	50	65	71	75	76	76	74	64
	B	46	62	67	71	73	72	71	60
	C	46	61	65	68	71	72	72	60

CRVB/6-400		63	125	250	500	1.000	2.000	4.000	8.000
Inlet	A	42	54	59	63	64	68	70	52
	B	42	53	58	61	63	67	68	50
	C	42	54	59	62	64	68	69	51
Outlet	A	45	57	63	67	68	68	63	52
	B	42	54	60	64	65	65	60	49
	C	44	54	58	63	66	67	62	49

CRVT/6-400		63	125	250	500	1.000	2.000	4.000	8.000
Inlet	A	42	54	59	63	64	68	70	52
	B	41	53	58	62	63	67	69	51
	C	42	54	59	62	64	68	69	51
Outlet	A	45	58	63	67	69	68	64	53
	B	42	55	60	64	66	65	61	50
	C	44	54	58	63	66	67	62	49

CRVB/4-450		63	125	250	500	1.000	2.000	4.000	8.000
Inlet	A	53	72	76	79	80	78	79	77
	B	53	69	73	75	75	73	71	67
	C	53	67	71	73	73	71	68	63
Outlet	A	56	75	81	83	83	82	83	81
	B	55	72	76	79	80	78	76	72
	C	53	70	74	77	78	76	74	70

CRVT/4-450		63	125	250	500	1.000	2.000	4.000	8.000
Inlet	A	52	71	75	78	78	77	78	74
	B	51	67	71	73	74	71	70	64
	C	52	66	69	72	71	69	66	61
Outlet	A	55	75	79	81	80	81	81	79
	B	53	70	74	77	78	76	74	70
	C	52	68	72	76	76	75	72	68

CRVB/6-450		63	125	250	500	1.000	2.000	4.000	8.000
Inlet	A	51	61	65	68	68	68	71	59
	B	48	56	60	62	62	60	62	45
	C	47	55	59	61	61	59	55	50
Outlet	A	51	64	68	70	71	72	72	61
	B	50	59	63	66	67	66	63	53
	C	49	58	62	65	66	64	62	52

CRVT/6-450		63	125	250	500	1.000	2.000	4.000	8.000
Inlet	A	51	61	65	68	68	68	71	59
	B	49	57	61	63	63	61	63	46
	C	47	56	59	62	61	59	56	51
Outlet	A	51	64	68	70	70	72	72	61
	B	50	59	64	67	68	66	64	54
	C	49	58	63	66	66	65	63	53

CRVB/4-500		63	125	250	500	1.000	2.000	4.000	8.000
Inlet	A	56	75	79	82	83	81	82	80
	B	56	72	76	78	78	76	74	70
	C	56	70	74	76	76	74	71	66
Outlet	A	59	78	84	86	86	85	86	84
	B	58	75	79	82	83	81	79	75
	C	56	73	77	80	81	79	77	73

CRVT/4-500		63	125	250	500	1.000	2.000	4.000	8.000
Inlet	A	55	74	78	81	81	80	81	77
	B	54	70	74	76	77	74	73	67
	C	55	69	72	75	74	72	69	64
Outlet	A	58	78	82	84	83	84	84	82
	B	56	73	77	80	81	79	77	73
	C	55	71	75	79	79	78	75	71

CRVB/6-500		63	125	250	500	1.000	2.000	4.000	8.000
Inlet	A	54	64	68	71	71	71	74	62
	B	51	59	63	65	65	63	65	48
	C	50	58	62	64	64	62	58	53
Outlet	A	54	67	71	73	74	75	75	64
	B	53	62	66	69	70	69	66	56
	C	52	61	65	68	69	67	65	55

CRVT/6-500		63	125	250	500	1.000	2.000	4.000	8.000
Inlet	A	54	64	68	71	71	71	74	62
	B	52	60	64	66	66	64	66	49
	C	50	59	62	65	64	62	59	54
Outlet	A	54	67	71	73	73	75	75	64
	B	53	62	67	70	71	69	67	57
	C	52	61	66	69	69	68	66	56

CRVB/8-500		63	125	250	500	1.000	2.000	4.000	8.000
Inlet	A	49	57	61	64	65	66	65	52
	B	46	53	56	59	58	58	55	36
	C	44	51	54	57	56	54	51	46
Outlet	A	51	59	62	65	66	68	68	50
	B	47	54	59	62	62	61	59	45
	C	46	53	58	61	62	60	58	44

CRVT/8-500		63	125	250	500	1.000	2.000	4.000	8.000
Inlet	A	48	56	60	63	63	66	63	50
	B	43	50	54	56	56	57	51	32
	C	42	49	52	55	55	52	49	44
Outlet	A	51	57	61	63	65	67	66	47
	B	44	52	57	60	60	59	55	41
	C	44	52	56	59	60	59	55	41

ACOUSTIC CHARACTERISTICS

Sound power spectrum in dB(A), at the fan inlet and outlet, at 3 working points of the performance curve (A: maximum airflow).

CRVB/6-560		63	125	250	500	1.000	2.000	4.000	8.000
Inlet	A	54	64	69	72	72	71	74	63
	B	52	61	64	67	66	64	66	50
	C	49	58	62	64	64	62	59	53
Outlet	A	55	68	72	74	74	75	76	65
	B	53	63	67	71	71	70	67	58
	C	52	62	66	69	70	68	66	56

CRVB/8-560		63	125	250	500	1.000	2.000	4.000	8.000
Inlet	A	50	58	62	65	65	67	66	53
	B	45	52	56	58	58	58	54	35
	C	44	51	54	57	56	54	51	46
Outlet	A	51	59	63	65	67	68	69	51
	B	46	54	58	62	62	61	58	44
	C	46	53	58	61	62	60	58	44

CRVB/6-630		63	125	250	500	1.000	2.000	4.000	8.000
Inlet	A	54	65	69	72	72	71	75	63
	B	52	61	64	67	66	64	66	50
	C	50	59	63	65	65	63	60	55
Outlet	A	55	68	72	74	74	76	76	66
	B	53	63	67	71	71	70	67	58
	C	52	62	66	70	70	69	66	57

CRVB/8-630		63	125	250	500	1.000	2.000	4.000	8.000
Inlet	A	51	59	63	66	66	68	68	54
	B	48	55	58	61	60	59	58	39
	C	46	53	57	59	59	57	54	49
Outlet	A	52	61	64	67	68	70	70	53
	B	59	56	61	64	65	63	61	48
	C	48	56	60	64	64	63	60	48

CRVT/4-560		63	125	250	500	1.000	2.000	4.000	8.000
Inlet	A	56	75	79	82	82	81	81	79
	B	55	72	75	78	77	75	74	69
	C	56	70	74	76	76	74	71	65
Outlet	A	59	78	83	86	85	85	85	84
	B	57	74	79	82	82	81	79	74
	C	56	72	77	80	81	79	77	72

CRVT/6-560		63	125	250	500	1.000	2.000	4.000	8.000
Inlet	A	54	64	68	71	72	71	74	63
	B	52	60	64	66	66	64	66	49
	C	50	59	62	65	64	62	59	54
Outlet	A	54	68	71	73	74	75	75	65
	B	53	62	67	70	71	69	67	57
	C	52	61	66	69	69	68	66	56

CRVT/8-560		63	125	250	500	1.000	2.000	4.000	8.000
Inlet	A	48	56	60	63	63	66	63	50
	B	43	50	54	56	56	57	51	32
	C	42	49	52	55	55	52	49	44
Outlet	A	51	57	61	63	65	67	66	47
	B	44	52	57	60	60	59	55	41
	C	44	52	56	59	60	59	55	41

CRVT/6-630		63	125	250	500	1.000	2.000	4.000	8.000
Inlet	A	54	65	69	72	72	71	75	63
	B	52	61	65	67	67	65	67	51
	C	50	59	63	65	65	63	60	55
Outlet	A	55	68	72	74	74	76	76	66
	B	53	63	68	71	71	70	68	58
	C	52	62	66	70	70	69	66	57

CRVT/8-630		63	125	250	500	1.000	2.000	4.000	8.000
Inlet	A	51	58	62	65	66	67	67	54
	B	47	54	58	60	60	59	57	38
	C	46	52	56	59	58	56	53	48
Outlet	A	52	60	64	66	68	69	69	53
	B	48	56	60	63	64	63	60	47
	C	48	55	60	63	63	62	60	47

DIMENSIONS (mm)

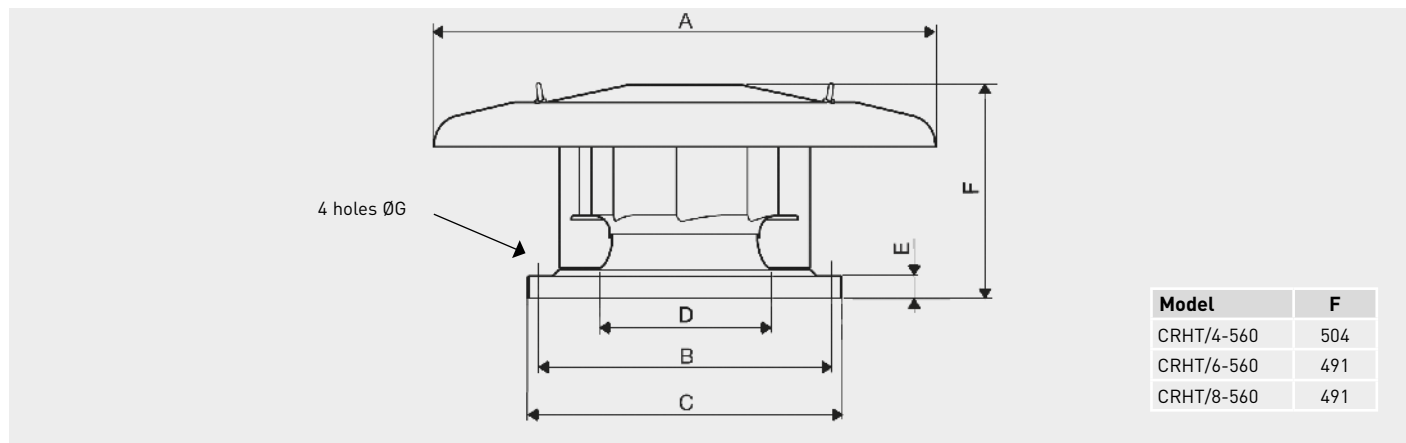

Model	ØA	ØB	ØC	ØD	E	F	ØG	Model	ØA	ØB	ØC	ØD	E	F	ØG
225	570	245	326	180	35	223	10	400	895	450	560	355	40	382	12
250	570	245	326	180	35	223	10	450	1150	535	630	400	40	418	12
280	570	330	435	250	40	250	12	500	1150	535	630	400	40	474	12
315	760	330	435	250	40	333	12	560	1150	590	710	500	40	See image	14
355	895	450	560	355	40	356,5	12	630	1150	750	905	630	50	546	14

INSTALLATION CRHB/CRHT

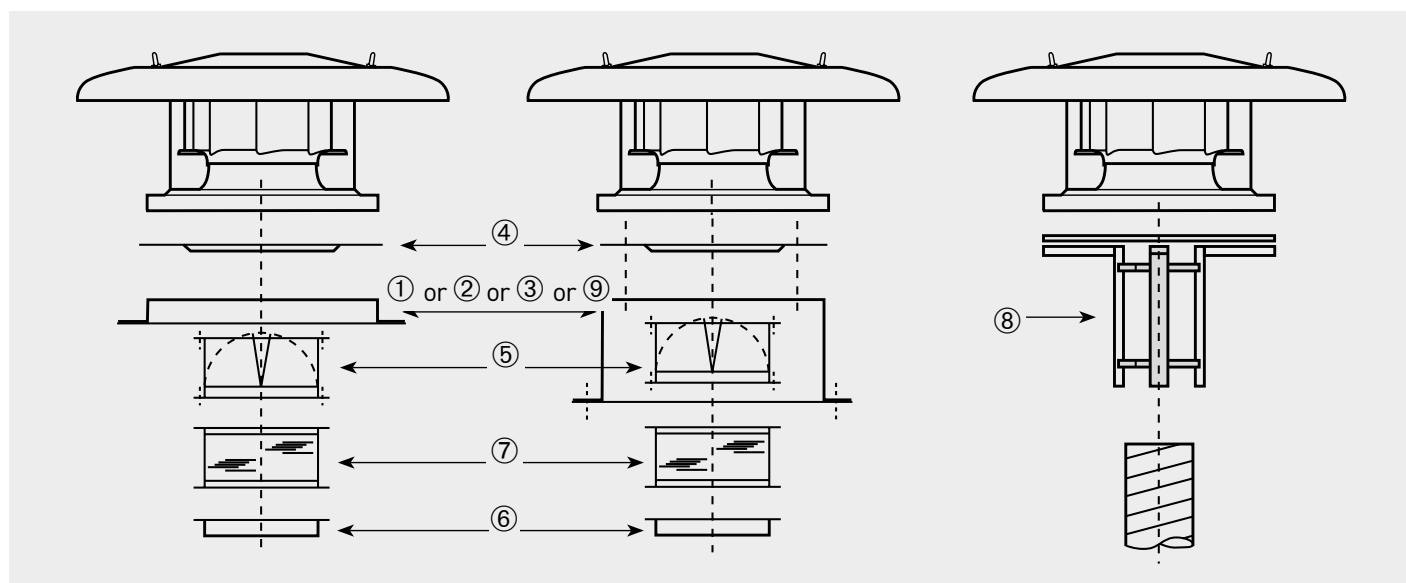

Model of fan	① Sealing frame	② Flat roof insulated up stand	③ Acoustic up stand	④ Accessory adapter plate	⑤ Back draft shutter	⑥ Flange with spigot	⑦ Flexible coupling	⑧ Circular adapter	⑨ Support base for inclined curb mounted installations
225 250	JMS-300	JBS-300	JAA-300	JPA-300	JCA-300	JBR-300 N	JAE-300 N	JCC-300	BI-3
280 315	JMS-435	JBS-435	JAA-435	JPA-435	JCA-435	JBR-435 N	JAE-435 N	JCC-435	BI-4
355 400	JMS-560	JBS-560	JAA-560	JPA-560	JCA-560 N	JBR-560 N	JAE-560 N	JCC-560	BI-5
450 500	JMS-630	JBS-630	JAA-630	JPA-630	JCA-630 N	JBR-630 N	JAE-630 N	JCC-630	BI-6
560	JMS-710	JBS-710	JAA-710	JPA-710	JCA-710 N	JBR-710 N	JAE-710 N	-	BI-7
630	JMS-905	JBS-905	JAA-905	JPA-905	JCA-905 N	JBR-905 N	JAE-905 N	-	BI-9

DIMENSIONS (mm)

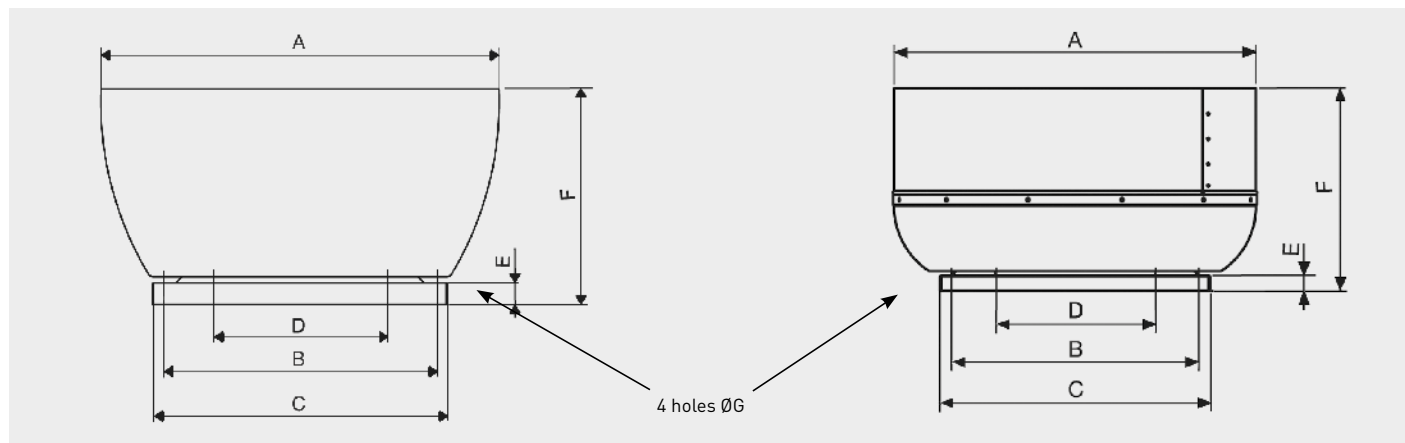

Model	ØA	∅B	∅C	ØD	E	F	ØG
225	434	245	326	180	40	257	10
250	434	245	326	180	40	257	10
280	560	330	435	250	40	317	12
315	560	330	435	250	40	347	12
355	754	450	560	355	40	407	12

Model	ØA	∅B	∅C	ØD	E	F	ØG
400	754	450	560	355	40	407	12
450	857	535	630	400	40	471	12
500	857	535	630	400	40	471	12
560	950	590	710	500	40	481	14
630	1216	750	905	630	50	634	14

INSTALLATION CRVB/CRVT

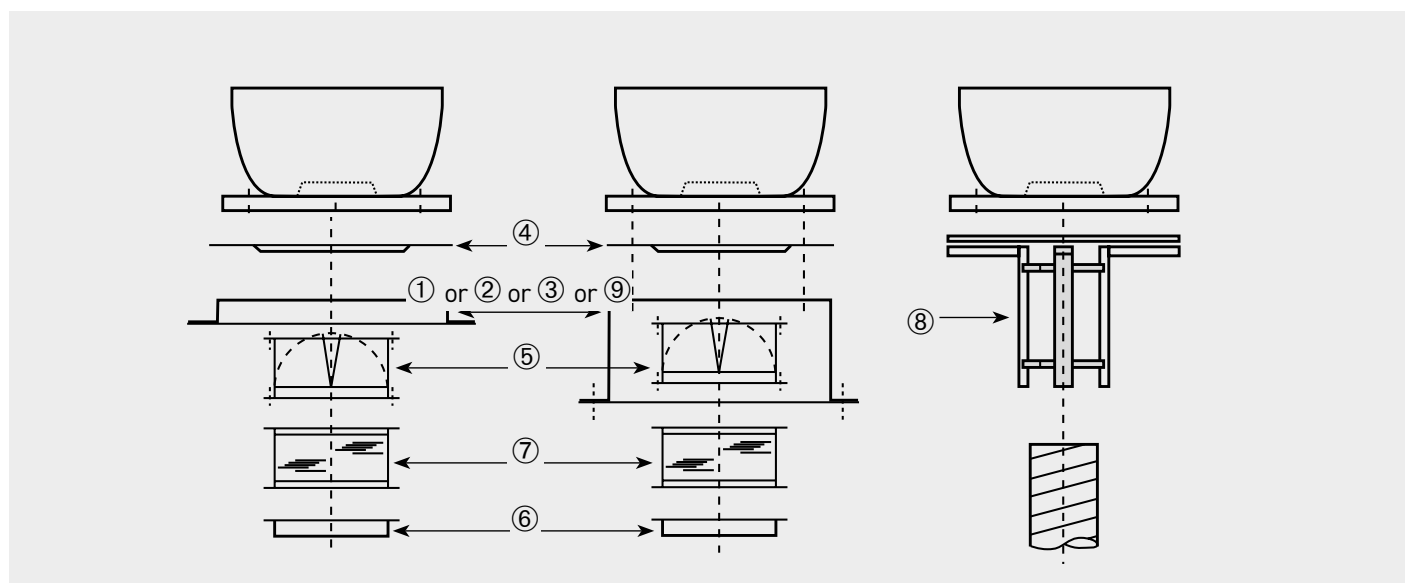

Model of fan	① Sealing frame	② Flat roof insulated up stand	③ Acoustic up stand	④ Accessory adapter plate	⑤ Back draft shutter	⑥ Flange with spigot	⑦ Flexible coupling	⑧ Circular adapter	⑨ Support base for inclined curb mounted installations
225 250	JMS-300	JBS-300	JAA-300	JPA-300	JCA-300	JBR-300 N	JAЕ-300 N	JCC-300	BI-3
280 315	JMS-435	JBS-435	JAA-435	JPA-435	JCA-435	JBR-435 N	JAЕ-435 N	JCC-435	BI-4
355 400	JMS-560	JBS-560	JAA-560	JPA-560	JCA-560 N	JBR-560 N	JAЕ-560 N	JCC-560	BI-5
450 500	JMS-630	JBS-630	JAA-630	JPA-630	JCA-630 N	JBR-630 N	JAЕ-630 N	JCC-630	BI-6
560	JMS-710	JBS-710	JAA-710	JPA-710	JCA-710 N	JBR-710 N	JAЕ-710 N	-	BI-7
630	JMS-905	JBS-905	JAA-905	JPA-905	JCA-905 N	JBR-905 N	JAЕ-905 N	-	BI-9

MOUNTING ACCESSORIES

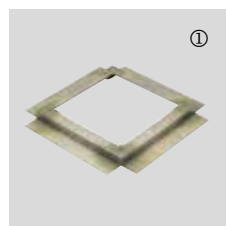

JMS
Sealing frame
- For mounting a roof fan on an up stand or base.
- Supplied with screws and gasket for a complete weatherproof seal.

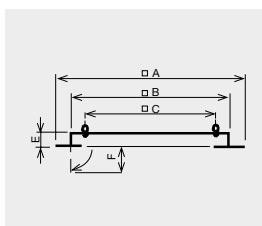

Model	□A	□B	□C	E	F
JMS-300	470	290	245	50	70
JMS-435	600	420	330	50	70
JMS-560	725	545	450	50	70
JMS-630	795	615	535	50	70
JMS-710	875	695	590	50	70
JMS-905	1065	885	750	60	70



JBS
Flat roof up stand
- For mounting a fan on a flat roof without up stands.
- For use on horizontal roofs.
- Internal insulation to prevent condensation.
- Supplied with screws and gasket for a complete weather seal.

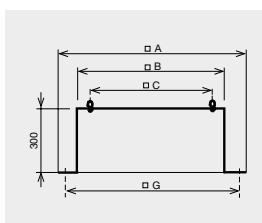

Model	□A	□B	□C	E	□G
JBS-300	470	289	245	300	380
JBS-435	600	419	330	300	510
JBS-560	725	544	450	300	635
JBS-630	795	614	535	300	705
JBS-710	875	694	590	300	785
JBS-905	1065	884	750	400	975

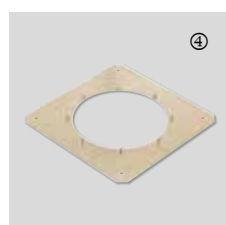

JPA
Accessory adapter plate
- Used when mounting the accessories (JCA, JBR, JAE).
- Allows the fan to be disconnected from the upstand without having to remove the duct.

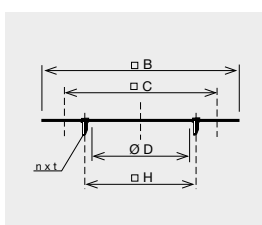

Model	□B	□C	∅ D	next	∅ H
JPA-300	289	245	182	4xM6	205
JPA-435	419	330	252	4xM8	280
JPA-560	544	450	358	8xM8	395
JPA-630	614	535	403	8xM10	450
JPA-710	694	590	503	12xM10	560
JPA-905	884	750	633	12xM10	690



JCA / JCA N
Backdraft shutter
- Prevents backdraft when the fan is not operating.
- To be mounted at the fan inlet with the JPA plate.

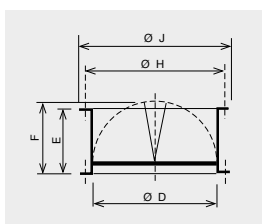

Model	∅ D	E	F	∅ H	∅ J
JCA-300	182	100	124	205	219
JCA-435	252	145	174	280	300
JCA-560 N	358	210	227	395	415
JCA-630 N	403	240	250	450	474
JCA-710 N	503	285	300	560	581
JCA-905 N	633	345	365	690	714



JBR N
Flange
- For use when circular connection is required directly to the fan.
- To be mounted at the fan inlet with the JPA plate or fixed directly to the fan base (rivets or screws not supplied).

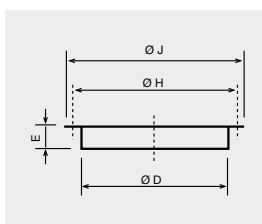

Model	∅ D	E	∅ H	∅ J
JBR-300 N	182	55	205	219
JBR-435 N	252	55	280	300
JBR-560 N	358	55	395	415
JBR-630 N	403	63	450	474
JBR-710 N	503	69	560	581
JBR-905 N	633	69	690	714



JAE N
Flexible coupling
- Reduces the transmission of vibrations when the duct is connected directly to the fan.
- To be mounted at the fan inlet with JPA plate.

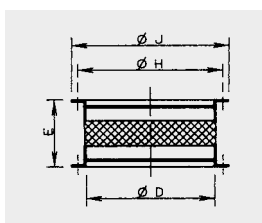

Model	∅ D	E	∅ H	∅ J
JAE-300 N	182	164	205	219
JAE-435 N	252	164	280	300
JAE-560 N	358	164	395	415
JAE-630 N	403	164	450	474
JAE-710 N	503	164	560	581
JAE-905 N	633	164	690	714



JCC
Adapter for circular duct
- For use when fitting the models up to 400, directly to a spirally wound circular duct.

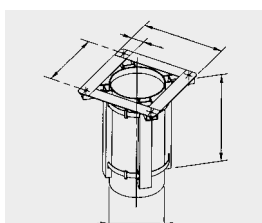

Model	∅ B	∅ C	∅ D	E	L
JCC-300	290	245	180	45	350
JCC-435	390	330	250	60	350
JCC-560	520	450	355	70	350
JCC-630	605	535	400	70	350

MOUNTING ACCESSORIES

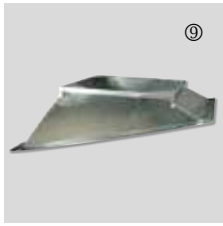

BI
Support base for inclined curb mounted installations
- To ensure a proper installation of the CRHB-CRHT roof fan it is essential to specify the roof pitch angle and the distance between the roof beam profiles.

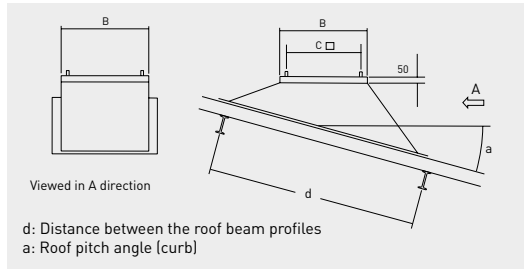

Model	B	C
BI-3	289	245
BI-4	419	330
BI-5	544	450
BI-6	614	535
BI-7	694	590
BI-9	884	750



JAA
Acoustic up stand
- Reduces in duct and radiated noise.
- For use when mounting a fan on a flat roof without up stands.
- Supplied with screws and gasket for a complete weather seal.

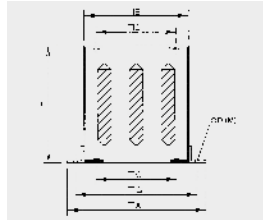

Model	□A	□B	□C	∅ D (M)	H	□G
JAA-300	470	290	245	13 (M10)	750	380
JAA-435	600	419	330	15 (M12)	750	510
JAA-560	725	545	450	15 (M12)	750	635
JAA-630	795	615	535	15 (M12)	750	705
JAA-710	875	695	590	18 (M14)	1000	785
JAA-905	1065	885	750	18 (M14)	1000	975

Acoustic attenuation in dB(A) at the corresponding frequency band in Hz.

Model	125	250	500	1000	2000	4000	8000
JAA-300	1	5	13	22	23	16	12
JAA-435	1	7	16	23	25	18	13
JAA-560	2	8	16	29	32	26	17
JAA-630	2	8	14	24	27	19	13
JAA-710	2	8	14	24	28	16	11
JAA-905	2	7	14	26	30	19	12
JAA-1100	2	7	16	27	32	20	13

JAA Attenuator pressure drops.

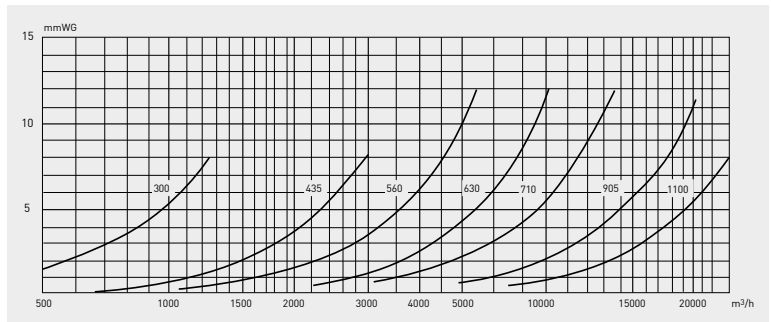

ELECTRICAL ACCESSORIES



REB
Single phase electronic speed controllers.



RMB / RMT
Auto transformer speed controllers.
- For single phase and three phase roof fans.



REB-5 / REB-10
Electronic single-phase speed controller.



COM D/S
Three phase fan Y / Δ switch
Enables to connect three phase fans.